

**tiio**®

**OTOMASYON**

**GWEST**®

**W**WOER®



**OCAK 2022**  
FİYAT LİSTESİ

## İÇİNDEKİLER

### Kablo Bağları ve Aksesuarları

Standart Beyaz Kablo Bağları .....	02
Standart Siyah Kablo Bağları .....	03
Standart Renkli Kablo Bağları .....	04
Ultraviole Kablo Bağları .....	05
Paslanmaz Çelik Kablo Bağları .....	06
PVC Kaplı Paslanmaz Çelik Kablo Bağları .....	07
Etiketli Kablo Bağları .....	08
Açılabilir Kablo Bağları .....	08
Distanslı Kablo Bağları .....	08
Yapışkanlı Kroşeler .....	09
Kapama Parçası .....	09
Kablo Kelepçesi .....	09
Kartuş Yükseltici .....	10
Beton Kroşe .....	10
Vidalı Kroşe .....	10
Kablo Bağı Etiket Taşıyıcı .....	11
Yapışkanlı Pano Etiket Taşıyıcı .....	11
Kablo İşaretleme Sistemleri .....	11
Helezon Spiraller .....	12

### Kablo Yüksükleri ve Uçları

İzoleli Kablo Yüksükleri Fransız Normu .....	14
İzoleli Kablo Yüksükleri Alman Normu .....	15
Çift Girişli Kablo Yüksükleri Fransız Normu .....	16
Çift Girişli Kablo Yüksükleri Alman Normu .....	17
İzolesiz Kablo Yüksükleri .....	18
Yuvarlak Tip İzoleli Kablo Uçları .....	20
Çatal Tip İzoleli Kablo Uçları .....	21
Ek Mufları İzoleli Kablo Uçları .....	22
Erkek Terminaller İzoleli Kablo Uçları .....	22
Dişi Terminaller İzoleli Kablo Uçları .....	22
Dişi Faston Tip İzoleli Kablo Uçları .....	23
Tam İzoleli Dişi Faston Tip Kablo Uçları .....	23
Tam İzoleli Polyamid Dişi Faston Tip Kablo Uçları .....	24
İğne Tip İzoleli Kablo Uçları .....	24
Erkek / Dişi Geri Dönüştürülebilir Terminaller .....	24
Erkek Faston Tip Terminaller .....	25
Tam İzoleli Polyamid Bayrak Tip Terminaller .....	25
İzolesiz Kablo Ucu ve Konnektörleri .....	26

### Bağlantı Elemanları

SKP Eko Tip Kablo Pabucu .....	28
SKP Eko Tip Kablo Pabucu .....	29
SKP Standart Tip Kablo Pabucu .....	30
SKP Standart Tip Kablo Pabucu .....	31
Ek Mufları .....	32
U Klemens .....	33
Delikli Montaj Rayları .....	34
Düz Montaj Rayları .....	34
Monofaze Müşterek W Otomat Baraları .....	35
Trifaze Müşterek W Otomat Baraları .....	35
2 Kutuplu Dağıtıcı Üniteler .....	36
4 Kutuplu Dağıtıcı Üniteler .....	37
Tek Kutuplu Dağıtıcı Üniteler .....	38
Tek Kutuplu Dağıtıcı Üniteler .....	39

### Kompakt Çok Amaçlı Klemensler

Geçmeli Buat Klemens .....	41
Çok Amaçlı Klemens .....	41

### Makaron Grubu ve Bant Çeşitleri

Isı ile Daralan Siyah Makaronlar .....	43
Isı ile Daralan Renkli Makaronlar .....	44
Isı ile Daralan Kahverengi Makaronlar .....	45
Isı ile Daralan Sarı / Yeşil Makaronlar .....	46
İçi Yapışkanlı Daralan Makaronlar .....	47
Kablo Toplama Çorabı .....	48
H Class Cam Elyaf Silikon İzoleli Makaronlar .....	49
Eriyen Bantlar.....	50
İzole Bantlar .....	50
Sıcak Hava Tabancası .....	50

# İÇİNDEKİLER

## Mekanik ve Hidrolik El Aletleri

Yüksük Sıkma Penseleri .....	52
İzolesiz Kablo Ucu ve Konnektör Sıkma Penseleri .....	53
İzoleli Kablo Ucu Sıkma Penseleri .....	53
Multi Fonksiyonel Yüksük ve Kablo Ucu Sıkma Pensesi .....	54
Kablo Sıyırma Pensesi .....	54
Kablo Bağı Sıkma Penseleri .....	54
Kablo Pabucu Sıkma Penseleri .....	55
Hidrolik Sıkma ve Kesme Penseleri .....	55
Kablo Kesme Makasları .....	56

## Buton Serisi ve Aksesuarları

Yaylı Butonlar .....	59
İşaretli Yaylı Butonlar .....	59
İşıklı Yaylı Butonlar .....	59
Kalıcı Mandal Butonlar .....	60
Kayıcı Mandal Butonlar .....	60
Kalıcı - Kayıcı Mandal Butonlar .....	60
Anahtarlı Kalıcı Butonlar .....	60
İşıklı Kalıcı Mandal Butonlar .....	61
40mm Kalıcı Mantar Butonlar .....	62
40mm Kalıcı Anahtarlı Mantar Butonlar .....	62
40mm Kayıcı Mantar Butonlar .....	62
40mm Kalıcı Mantar Butonlar .....	62
İkiz Butonlar .....	62
Buton Serisi Aksesuarları .....	63
Boş Kumanda Kutuları .....	64
Kutulu Acil Stop Buton .....	64
Vinç Kumandaları .....	65
Acil Stoplu Vinç Kumandaları .....	65
Ø 22mm Voltmetre .....	66
Ø 22mm Ampermetre .....	66
Ø 22mm Led'li Sinyaller .....	67
Ø 16mm Led'li Sinyaller .....	67
BA9S Led Ampuller .....	68
Ø 22mm Led'li Buzzer .....	69
Motorlu Sirenler .....	69
Pano İçi Termostatlar .....	69
Ø 22mm Potansiyometre .....	70
Aks Serisi Kapı Switch .....	70

## Switch Grubu

GLS Serisi Limit Switch .....	72
GLS Serisi Limit Switch .....	73
GLS Serisi Limit Switch .....	74
GLS Serisi Limit Switch .....	75
AZ Serisi Mikro Switch .....	76
AZ Serisi Mikro Switch .....	77
AZ Serisi Mikro Switch .....	78
GMS Serisi Mikro Switch .....	79

## Ayak Pedalları

Metal Döküm Pedal .....	81
Alüminyum Döküm Pedal .....	81



Bu fiyat listesindeki tipografik baskı hatalarından firmamız sorumlu değildir.  
Firmamız fiyat listesinde yayınlanmış olduğu teknik özellikleri değiştirme, döviz ve hammadde artışlarından dolayı meydana gelebilecek fiyat artışlarını hiçbir uyarıda bulunmaksızın fiyat listesine yansıtma hakkına sahiptir.



## Başarılar Karşılıklı GÜVEN'e Bağlıdır.

Şirketimiz 2004 yılında kurulmuş olup kurulduğu tarihten bugüne ithalatlarına ve imalatlarına her sene üzerine ekleyerek devam etmektedir. Genç ve dinamik yapısı ile müşterilerinin ihtiyaçlarına hızlı, etkili ve pratik çözümler sunmaktadır. Bugün'e kadar çalışmış olduğu müşterilerine koşulsuz müşteri memnuniyeti yaşatan Güven Elektrik hizmetlerine kalite standartlarını yükselterek devam etmektedir.

Firmamıza ait olan tescilli GWEST, WOER markaları ile siz değerli müşterilerimize 19 yıllık tecrübe ve müşteri memnuniyetini ilke edinerek hizmet vermekten mutluluk duyuyoruz.

**GWEST**®

**WOER**®

Whatsapp Sipariş Destek Hattı  
**+90 850 304 88 36**

[www.guvenelektrik.com.tr](http://www.guvenelektrik.com.tr)



# KABLO BAĞLARI

VE AKSESUARLARI



# STANDART BEYAZ KABLO BAĞLARI

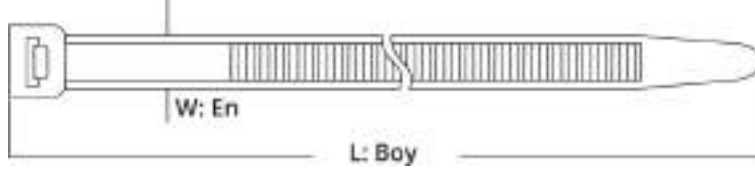

Malzeme :  
Saf Naylon 6.6 Standart UL  
Çalışma Sıcaklığı :  
- 40 ° C --- +85 ° C

Sipariş Kodu	Ürün Kodu	Boyutlar		Renk	Maksimum Sıkma Çapı (mm)	Açılma Mukavemeti (kg)	Ambalaj Adet		Birim Fiyat TL / Adet
		Uzunluk (mm)	En (mm)				Paket	Koli	
1001	GT 100 M	100	2.5	Beyaz	20	8	1.000	70.000	0.117
1002	GT 150 M	150		Beyaz	36		1.000	55.000	0.185
1003	GT 200 M	200		Beyaz	52		1.000	32.000	0.265
1004	GT 150 I	150	3.6	Beyaz	36	18	100	30.000	0.310
1005	GT 200 I	200		Beyaz	52		100	20.000	0.405
1006	GT 250 I	250		Beyaz	68		100	20.000	0.495
1007	GT 300 I	300		Beyaz	84		100	17.000	0.610
1008	GT 370 I	370		Beyaz	106		100	12.000	0.780
1009	GT 200 ST	200	4.8	Beyaz	50	22	100	16.000	0.580
1010	GT 250 ST	250		Beyaz	65		100	12.000	0.700
1011	GT 300 ST	300		Beyaz	81		100	11.000	0.850
1012	GT 370 ST	370		Beyaz	104		100	9.000	0.980
1050	GT 400 ST	400		Beyaz	113		100	6.500	1.130
1013	GT 430 ST	430		Beyaz	123		100	7.500	1.320
1014	GT 530 ST	530		Beyaz	160		100	5.000	1.750
1015	GT 300 HD	300	7.6	Beyaz	76	55	100	5.000	1.690
1016	GT 370 HD	370		Beyaz	102		100	4.000	1.870
1017	GT 430 HD	430		Beyaz	110		100	2.500	2.200
1018	GT 530 HD	530		Beyaz	140		100	2.000	2.900
1019	GT 610 HD	610		Beyaz	185		100	2.000	3.250
1020	GT 750 HD	750		Beyaz	226		100	2.000	4.500
1022	GT 710 HD	710	9	Beyaz	190	80	100	2.000	4.900
1023	GT 780 HD	780		Beyaz	228		100	2.000	5.800
1024	GT 920 HD	920		Beyaz	280		100	1.000	6.700
1025	GT 1020 HD	1020		Beyaz	295		100	1.000	7.000
1026	GT 1220 HD	1220		Beyaz	375		100	1.000	8.700

## STANDART SİYAH KABLO BAĞLARI

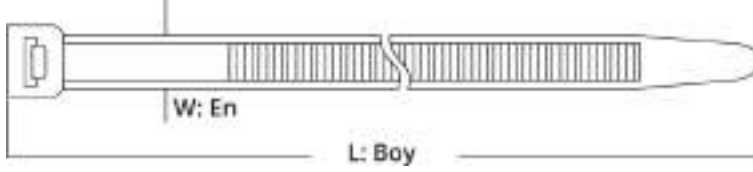

Malzeme :

Saf Naylon 6.6 Standart UL

Çalışma Sıcaklığı :

- 40 °C --- +85 °C

Sipariş Kodu	Ürün Kodu	Boyutlar		Renk	Maksimum Sıkma Çapı (mm)	Açılma Mukavemeti (kg)	Ambalaj Adet		Birim Fiyat TL / Adet
		Uzunluk (mm)	En (mm)				Paket	Koli	
1027	GT 100 MB	100	2.5	Siyah	20	8	1.000	70.000	0.117
1028	GT 150 MB	150		Siyah	36		1.000	55.000	0.185
1029	GT 200 MB	200		Siyah	52		1.000	32.000	0.265
1030	GT 150 IB	150	3.6	Siyah	36	18	100	30.000	0.310
1031	GT 200 IB	200		Siyah	52		100	20.000	0.405
1032	GT 250 IB	250		Siyah	68		100	20.000	0.495
1033	GT 300 IB	300		Siyah	84		100	17.000	0.610
1034	GT 370 IB	370		Siyah	106		100	12.000	0.780
1035	GT 200 STB	200	4.8	Siyah	50	22	100	16.000	0.580
1036	GT 250 STB	250		Siyah	65		100	12.000	0.700
1037	GT 300 STB	300		Siyah	81		100	11.000	0.850
1038	GT 370 STB	370		Siyah	104		100	9.000	0.980
1039	GT 430 STB	430		Siyah	123		100	7.500	1.320
1040	GT 530 STB	530		Siyah	160		100	5.000	1.750
1041	GT 300 HDB	300	7.6	Siyah	76	55	100	5.000	1.690
1042	GT 370 HDB	370		Siyah	102		100	4.000	1.870
1043	GT 430 HDB	430		Siyah	110		100	2.500	2.200
1044	GT 530 HDB	530		Siyah	140		100	2.000	2.900
1045	GT 610 HDB	610		Siyah	185		100	2.000	3.250
1048	GT 710 HDB	710	9	Siyah	190	80	100	2.000	4.900
1049	GT 780 HDB	780		Siyah	228		100	2.000	5.800

## STANDART RENKLİ KABLO BAĞLARI

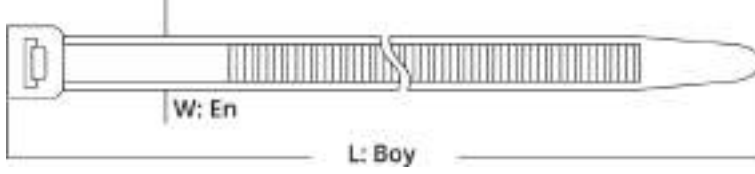

Malzeme :

Saf Naylon 6.6 Standart UL

Çalışma Sıcaklığı :

- 40 ° C --- +85 ° C

Sipariş Kodu	Ürün Kodu	Boyutlar		Renk	Maksimum Sıkma Çapı (mm)	Açılma Mukavemeti (kg)	Ambalaj Adet		Birim Fiyat TL / Adet
		Uzunluk (mm)	En (mm)				Paket	Koli	
1101	GT 100 MK	100	2.5	Kırmızı	20	8	1.000	70.000	0.135
1102	GT 150 IK	150	3.6	Kırmızı	36	18	100	30.000	0.345
1103	GT 200 IK	200		Kırmızı	52		100	20.000	0.450
1104	GT 250 IK	250		Kırmızı	68		100	20.000	0.550
1105	GT 300 IK	300		Kırmızı	84		100	17.000	0.670
1106	GT 200 STK	200	4.8	Kırmızı	50	22	100	16.000	0.630
1107	GT 250 STK	250		Kırmızı	65		100	12.000	0.770
1108	GT 300 STK	300		Kırmızı	81		100	11.000	0.940
1109	GT 370 STK	370		Kırmızı	101		100	9.000	1.100
1110	GT 100 MM	100	2.5	Mavi	20	8	1.000	70.000	0.135
1111	GT 150 IM	150	3.6	Mavi	36	18	100	30.000	0.345
1112	GT 200 IM	200		Mavi	52		100	20.000	0.450
1113	GT 250 IM	250		Mavi	68		100	20.000	0.550
1114	GT 300 IM	300		Mavi	84		100	17.000	0.670
1115	GT 200 STM	200	4.8	Mavi	50	22	100	16.000	0.630
1116	GT 250 STM	250		Mavi	65		100	12.000	0.770
1117	GT 300 STM	300		Mavi	81		100	11.000	0.940
1118	GT 370 STM	370		Mavi	101		100	9.000	1.100
1119	GT 100 MS	100	2.5	Sarı	20	8	1.000	70.000	0.135
1120	GT 150 IS	150	3.6	Sarı	36	18	100	30.000	0.345
1121	GT 200 IS	200		Sarı	52		100	20.000	0.450
1122	GT 250 IS	250		Sarı	68		100	20.000	0.550
1123	GT 300 IS	300		Sarı	84		100	17.000	0.670
1124	GT 200 STS	200	4.8	Sarı	50	22	100	16.000	0.630
1125	GT 250 STS	250		Sarı	65		100	12.000	0.770
1126	GT 300 STS	300		Sarı	81		100	11.000	0.940
1127	GT 370 STS	370		Sarı	104		100	9.000	1.100
1128	GT 100 MY	100	2.5	Yeşil	20	8	1.000	70.000	0.135
1129	GT 150 IY	150	3.6	Yeşil	36	18	100	30.000	0.345
1130	GT 200 IY	200		Yeşil	52		100	20.000	0.450
1131	GT 250 IY	250		Yeşil	68		100	20.000	0.550
1132	GT 300 IY	300		Yeşil	84		100	17.000	0.670
1133	GT 200 STY	200	4.8	Yeşil	50	22	100	16.000	0.630
1134	GT 250 STY	250		Yeşil	65		100	12.000	0.770
1135	GT 300 STY	300		Yeşil	81		100	11.000	0.940
1136	GT 370 STY	370		Yeşil	101		100	9.000	1.100



## ULTRAVİOLE KABLO BAĞLARI

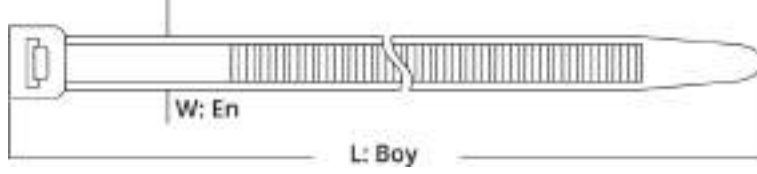

Malzeme :  
Saf Naylon 6.6 Standart UL  
Çalışma Sıcaklığı :  
- 40 ° C --- +85 ° C

Sipariş Kodu	Ürün Kodu	Boyutlar		Renk	Maksimum Sıkma Çapı (mm)	Açılma Mukavemeti (kg)	Ambalaj Adet		Birim Fiyat TL / Adet
		Uzunluk (mm)	En (mm)				Paket	Koli	
1201	GT 100 M UV	100	2.5	Siyah	20	8	1.000	70.000	0.135
1202	GT 150 M UV	150		Siyah	36		1.000	55.000	0.205
1203	GT 200 M UV	200		Siyah	52		1.000	32.000	0.295
1204	GT 150 I UV	150	3.6	Siyah	36	18	100	30.000	0.340
1205	GT 200 I UV	200		Siyah	52		100	20.000	0.440
1206	GT 250 I UV	250		Siyah	68		100	20.000	0.540
1207	GT 300 I UV	300		Siyah	84		100	17.000	0.660
1208	GT 200 ST UV	200	4.8	Siyah	50	22	100	16.000	0.630
1209	GT 250 ST UV	250		Siyah	65		100	12.000	0.770
1210	GT 300 ST UV	300		Siyah	81		100	11.000	0.930
1211	GT 370 ST UV	370		Siyah	104		100	9.000	1.100
1212	GT 430 ST UV	430		Siyah	123		100	7.500	1.420
1213	GT 300 HD UV	300	7.6	Siyah	76	55	100	5.000	1.850
1214	GT 370 HD UV	370		Siyah	102		100	4.000	2.000
1215	GT 430 HD UV	430		Siyah	110		100	2.500	2.350
1216	GT 530 HD UV	530		Siyah	140		100	2.000	3.100
1217	GT 780 HD UV	780	9	Siyah	228	80	100	2.000	6.700



## PASLANMAZ ÇELİK KABLO BAĞLARI

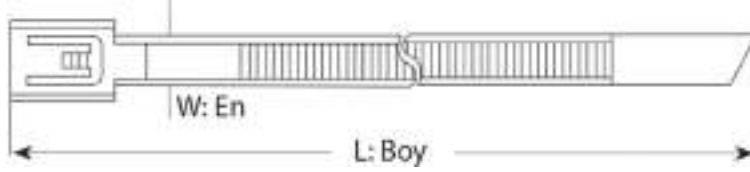

Malzeme : 304 Paslanmaz Çelik  
Su emilimi: Yok  
Alev yürümeme : UL94V-2

Sipariş Kodu	Ürün Kodu	Boyutlar		Renk	Maksimum Sıkma Çapı (mm)	Açılma Mukavemeti (kg)	Ambalaj Adet		Birim Fiyat TL / Adet
		Uzunluk (mm)	En (mm)				Paket	Koli	
1301	MTL 150 ST	150	4.6	Metal	44	55	100	8.000	2.50
1302	MTL 200 ST	200		Metal	51		100	6.000	2.80
1303	MTL 260 ST	260		Metal	69		100	5.000	3.10
1304	MTL 300 ST	300		Metal	76		100	5.000	3.30
1305	MTL 370 ST	370		Metal	102		100	4.000	3.65
1306	MTL 520 ST	520		Metal	152		100	3.000	4.70
1307	MTL 680 ST	680		Metal	203		100	2.000	5.60
1308	MTL 840 ST	840		Metal	254		100	1.000	6.80
1309	MTL 200 HD	200	7.9	Metal	50	120	100	5.000	4.00
1310	MTL 300 HD	300		Metal	75		100	4.000	4.50
1311	MTL 370 HD	370		Metal	102		100	3.000	5.10
1312	MTL 520 HD	520		Metal	152		100	2.000	6.70
1313	MTL 680 HD	680		Metal	203		100	2.000	8.50
1314	MTL 840 HD	840		Metal	224		100	1.000	9.40

### Paslanmaz Çelik Kablo Bağları

- Kendiliğinden kilitlenebilir kafa tasarımı, kurulumu hızlandırır ve kablo bağı gövdesi boyunca herhangi bir boyda kilitlemeyi sağlar.
- Güçlü ve dayanıklı kablo bağlama yöntemini temin eder.
- Çok çeşitli iç mekân ve dış mekân uygulama alanlarında kullanılabilir.
- Pürüzsüz yüzeyi ve yuvarlatılmış uçları ile kabloların korunmasını ve çalışan kişinin güvenliğini garanti eder.
- Şebeke kablolarında en üst düzey desteği sağlar.
- Genel amaçlı uygulamalar için : 304 paslanmaz çelik



# PVC KAPLI PASLANMAZ ÇELİK KABLO BAĞLARI

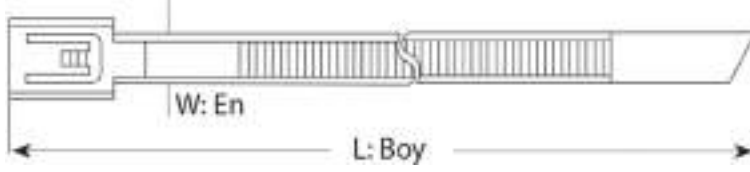

Malzeme : 304 Paslanmaz Çelik  
Su emilimi: Yok  
Alev yürümeme : UL94V-2

Sipariş Kodu	Ürün Kodu	Boyutlar		Renk	Maksimum Sıkma Çapı (mm)	Açılma Mukavemeti (kg)	Ambalaj Adet		Birim Fiyat TL / Adet
		Uzunluk (mm)	En (mm)				Paket	Koli	
1401	PVC MTL 150 ST	150	4.6	Metal	44	55	100	8.000	3.60
1402	PVC MTL 200 ST	200		Metal	51		100	6.000	4.00
1403	PVC MTL 260 ST	260		Metal	69		100	5.000	4.30
1404	PVC MTL 300 ST	300		Metal	76		100	5.000	4.40
1405	PVC MTL 370 ST	370		Metal	102		100	4.000	5.70
1406	PVC MTL 520 ST	520		Metal	152		100	3.000	7.30
1407	PVC MTL 680 ST	680		Metal	203		100	2.000	9.50
1408	PVC MTL 840 ST	840		Metal	254		100	1.000	11.50
1409	PVC MTL 200 HD	200	7.9	Metal	50	120	100	5.000	5.00
1410	PVC MTL 300 HD	300		Metal	75		100	4.000	6.10
1411	PVC MTL 370 HD	370		Metal	102		100	3.000	7.00
1412	PVC MTL 520 HD	520		Metal	152		100	2.000	9.30
1413	PVC MTL 680 HD	680		Metal	203		100	2.000	12.00
1414	PVC MTL 840 HD	840		Metal	224		100	1.000	16.00

## PVC Kaplı Paslanmaz Çelik Kablo Bağları

- Kendiliğinden kilitlenebilir kafa tasarımı, kurulumu hızlandırır ve kablo bağı gövdesi boyunca herhangi bir boyda kilitlemeyi sağlar.
- Güçlü ve dayanıklı kablo bağlama yöntemini temin eder.
- Çok çeşitli iç mekân ve dış mekân uygulama alanlarında kullanılabilir.
- Pürüzsüz yüzeyi ve yuvarlatılmış uçları ile kablonun korunmasını ve çalışan kişinin güvenliğini garanti eder.
- Şebeke kablolarında en üst düzey desteği sağlar.
- Genel amaçlı uygulamalar için : 304 paslanmaz çelik



## ETİKETLİ KABLO BAĞLARI

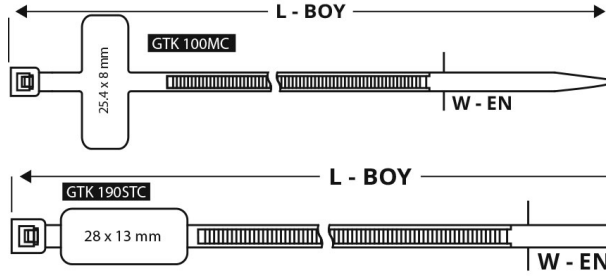

Malzeme :  
Saf Naylon 6.6 Standart UL  
Çalışma Sıcaklığı :  
- 40 ° C --- +85 ° C

Sipariş Kodu	Ürün Kodu	Boyutlar		Renk	Maksimum Sıkma Çapı (mm)	Açılma Mukavemeti (kg)	Ambalaj Adet		Birim Fiyat TL / Adet
		Uzunluk (mm)	En (mm)				Paket	Koli	
1501	GTK 100 MC	100	2.5	Beyaz	20	8	100	30.000	0.375
1502	GTK 190 STC	190	4.8	Beyaz	48	22	100	12.000	1.00

## AÇILABİLİR KABLO BAĞLARI

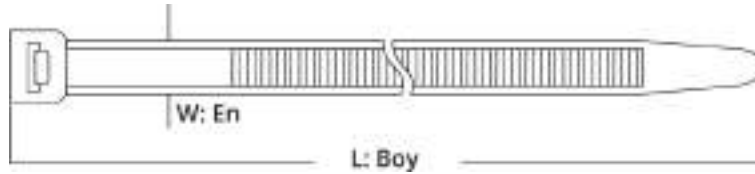

Malzeme :  
Saf Naylon 6.6 Standart UL  
Çalışma Sıcaklığı :  
- 40 ° C --- +85 ° C

Sipariş Kodu	Ürün Kodu	Boyutlar		Renk	Maksimum Sıkma Çapı (mm)	Açılma Mukavemeti (kg)	Ambalaj Adet		Birim Fiyat TL / Adet
		Uzunluk (mm)	En (mm)				Paket	Koli	
1503	GTA 200 HD	200	7.6	Beyaz	50	36	100	5.000	1.40
1504	GTA 370 HD	370	7.6	Beyaz	100	36	100	3.000	2.40

## DİSTANSLI KABLO BAĞLARI

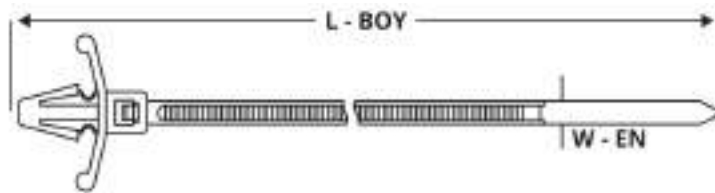

Malzeme :  
Saf Naylon 6.6 Standart UL  
Çalışma Sıcaklığı :  
- 40 ° C --- +85 ° C

Sipariş Kodu	Ürün Kodu	Boyutlar		Renk	Maksimum Sıkma Çapı (mm)	Açılma Mukavemeti (kg)	Ambalaj Adet		Birim Fiyat TL / Adet
		Uzunluk (mm)	En (mm)				Paket	Koli	
1505	GTP 100 M	100	2.5	Beyaz	20	8	100	50.000	0.380
1506	GTP 150 I	150	3.6	Beyaz	35	18	100	30.000	0.620
1507	GTP 200 ST	200	4.8	Beyaz	50	22	100	12.000	1.20

## YAPIŞKANLI KROŞE

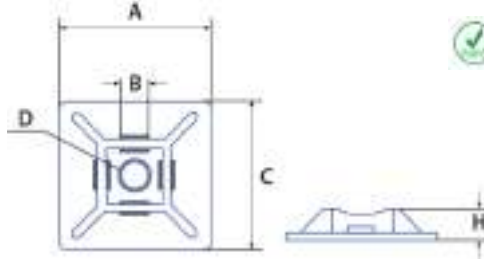
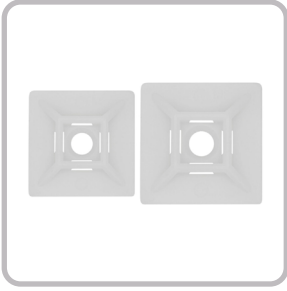

Malzeme :

Saf Naylon 6.6 Standart UL

Çalışma Sıcaklığı :

- 40 ° C --- +85 ° C

Sipariş Kodu	Ürün Kodu	Boyutlar					Renk	Ambalaj Adet		Birim Fiyat TL / Adet
		A	B	C	D	H		Paket	Koli	
1513	HW - 3A	19	19	3.6	Ø 3.2	4.0	Beyaz	100	20.000	0.54
1514	HW - 4A	28	28	4.8	Ø 3.2	4.5	Beyaz	100	9.000	0.90
1515	HW - 3AB	19	19	3.6	Ø 3.2	4.0	Siyah	100	20.000	0.54
1516	HW - 4AB	28	28	4.8	Ø 3.2	4.5	Siyah	100	9.000	0.90

## KAPAMA PARÇASI

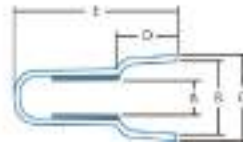
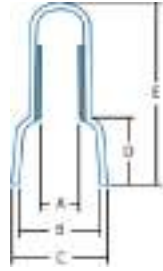

Malzeme :

Saf Naylon 6.6 Standart UL

Çalışma Sıcaklığı :

- 40 ° C --- +85 ° C

Sipariş Kodu	Ürün Kodu	Boyutlar					Renk	Ambalaj Adet		Birim Fiyat TL / Adet
		A	B	C	D	H		Paket	Koli	
1517	HW - C4	19	19	3.6	Ø 3.2	4.0	Beyaz	100	20.000	0.245
1518	HW - C5	28	28	4.8	Ø 3.2	4.5	Beyaz	100	9.000	0.455

## KABLO KELEPÇESİ

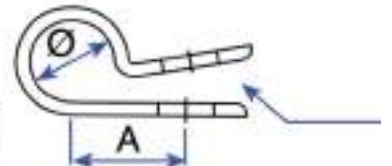
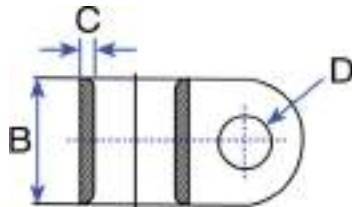

Sipariş Kodu	Ürün Kodu	Boyutlar						Renk	Ambalaj Adet		Birim Fiyat TL / Adet
		Ø	Ø 1	A	B	C	D		Paket	Koli	
1523	GCL 1/4	7.4	6.6	10.3	9.1	1.27	M5	Beyaz	100	30.000	0.42
1524	GCL 3/8	10.9	9.7	11.9	9.2	1.27	M5	Beyaz	100	20.000	0.50

## KARTUŞ YÜKSELTİCİ

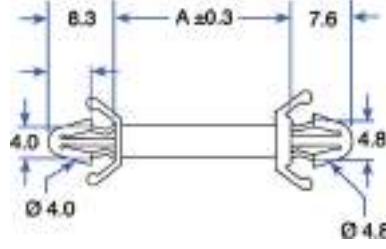
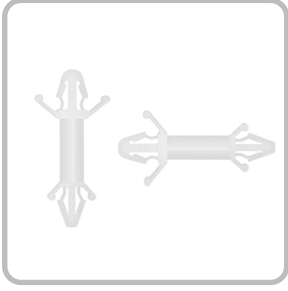

Malzeme :  
Saf Naylon 6.6 Standart UL  
Çalışma Sıcaklığı :  
- 40 ° C --- +85 ° C

Sipariş Kodu	Ürün Kodu	Boyutlar		Renk	Ambalaj Adet		Birim Fiyat TL / Adet
		A			Paket	Koli	
1519	CBS - 9A	9.2		Beyaz	1.000	40.000	0.50
1520	CBS - 13A	12.6		Beyaz	1.000	30.000	0.52
1521	CBS - 16A	15.8		Beyaz	1.000	25.000	0.59

## BETON KROŞE

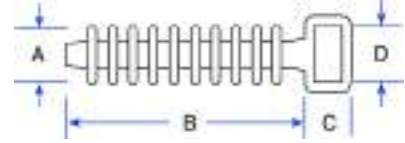

Sipariş Kodu	Ürün Kodu	Boyutlar				Maksimum Sıkma Çapı (mm)	Renk	Ambalaj Adet		Birim Fiyat TL / Adet
		A	B	C	D			Paket	Koli	
1525	TH - 2	9.5	36.0	6.0	9.5	9.5	Siyah	100	8.000	0.66

## VİDALI KROŞE

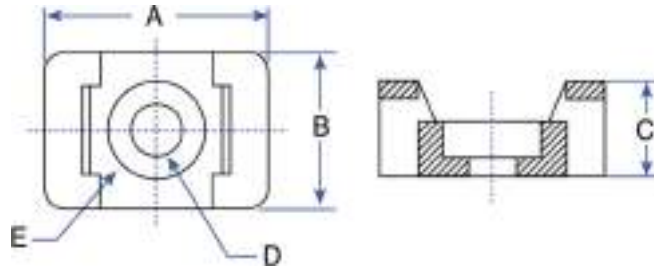

Sipariş Kodu	Ürün Kodu	Boyutlar					Maksimum Sıkma Çapı (mm)	Renk	Ambalaj Adet		Birim Fiyat TL / Adet
		A	B	C	D	E			Paket	Koli	
1511	VK V - 1	14.9	9.5	6.9	4.5	7.8	4.8	Beyaz	100	5.000	0.40
1512	VK V - 2	22.2	15.9	9.7	6.4	12.6	7.6	Beyaz	100	5.000	0.57

## KABLO BAĞI ETİKET TAŞIYICI

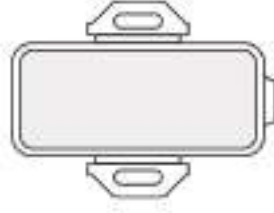

Malzeme :  
Polipropilen  
Çalışma Sıcaklığı :  
0 ° C --- +90 ° C

Sipariş Kodu	Ürün Kodu	Boyutlar			Etiket Eni (mm)	Etiket Boyu (mm)	Renk	Ambalaj Adet		Birim Fiyat TL / Adet
		A	B	C				Paket	Koli	
1526	GET - 1	35	10	8	32	7	Beyaz	100	8.000	1.05
1527	GET - 2	45	20	8	42	17	Beyaz	100	4.000	1.80

## YAPIŞKANLI PANO ETİKET TAŞIYICI



Malzeme :  
ABS Altık, PS Kapak + Çift Taraflı Bant  
Çalışma Sıcaklığı :  
-40 ° C --- +60 ° C

Sipariş Kodu	Ürün Kodu	Boyutlar		Etiket Eni (mm)	Etiket Boyu (mm)	Renk	Ambalaj Adet		Birim Fiyat TL / Adet
		A	B				Paket	Koli	
1528	GPET - 1	30	17	27.5	14.4	Siyah	100	8.000	1.25
1529	GPET - 2	50	17	49	15	Siyah	50	5.000	1.70
1530	GPET - 3	75	17	72	15	Siyah	25	3.000	2.35

## KABLO İŞARETLEME SİSTEMLERİ



BASKI NUMARASI	EC-0		EC-1		EC-2	
	KESİT: 0.50-1mm Kablolar için MAKARA : 1000 Ad.		KESİT: 1.50-6mm Kablolar için MAKARA : 1000 Ad.		KESİT: 4-16mm Kablolar için MAKARA :500 Ad.	
	Sipariş Kodu	Fiyat	Sipariş Kodu	Fiyat	Sipariş Kodu	Fiyat
0	1601	40.00 TL	1611	40.00 TL	1621	40.00 TL
1	1602		1612		1622	
2	1603		1613		1623	
3	1604		1614		1624	
4	1605		1615		1625	
5	1606		1616		1626	
6	1607		1617		1627	
7	1608		1618		1628	
8	1609		1619		1629	
9	1610		1620		1630	

## HELEZON SPİRALLER

Sipariş Kodu	Ürün Kodu	O.D.	T	W	Kablo Kesit (mm <sup>2</sup> )	Renk	Paket Miktarı (Mt.)	Koli Miktarı (Mt.)	Birim Fiyat TL / Mt.
3251	GHS6 (No1)	6	0.60	7.4	2.5 - 15	Beyaz	10	1.000	2.30
3252	GHS8 (No2)	8	0.75	12	6 - 30	Beyaz	10	800	2.90
3253	GHS10 (No3)	10	0.80	12.3	7.5 - 30	Beyaz	10	500	4.10
3254	GHS12 (No4)	12	0.85	15	9 - 32	Beyaz	10	400	5.30
3255	GHS15 (No5)	15	1.00	15.5	12 - 35	Beyaz	10	250	8.50

Malzeme : PE

Esnek yapısı sayesinde kabloların düzenlemesine yardımcı olur

Güçlü yapısı sayesinde tekrar kullanım için uygundur

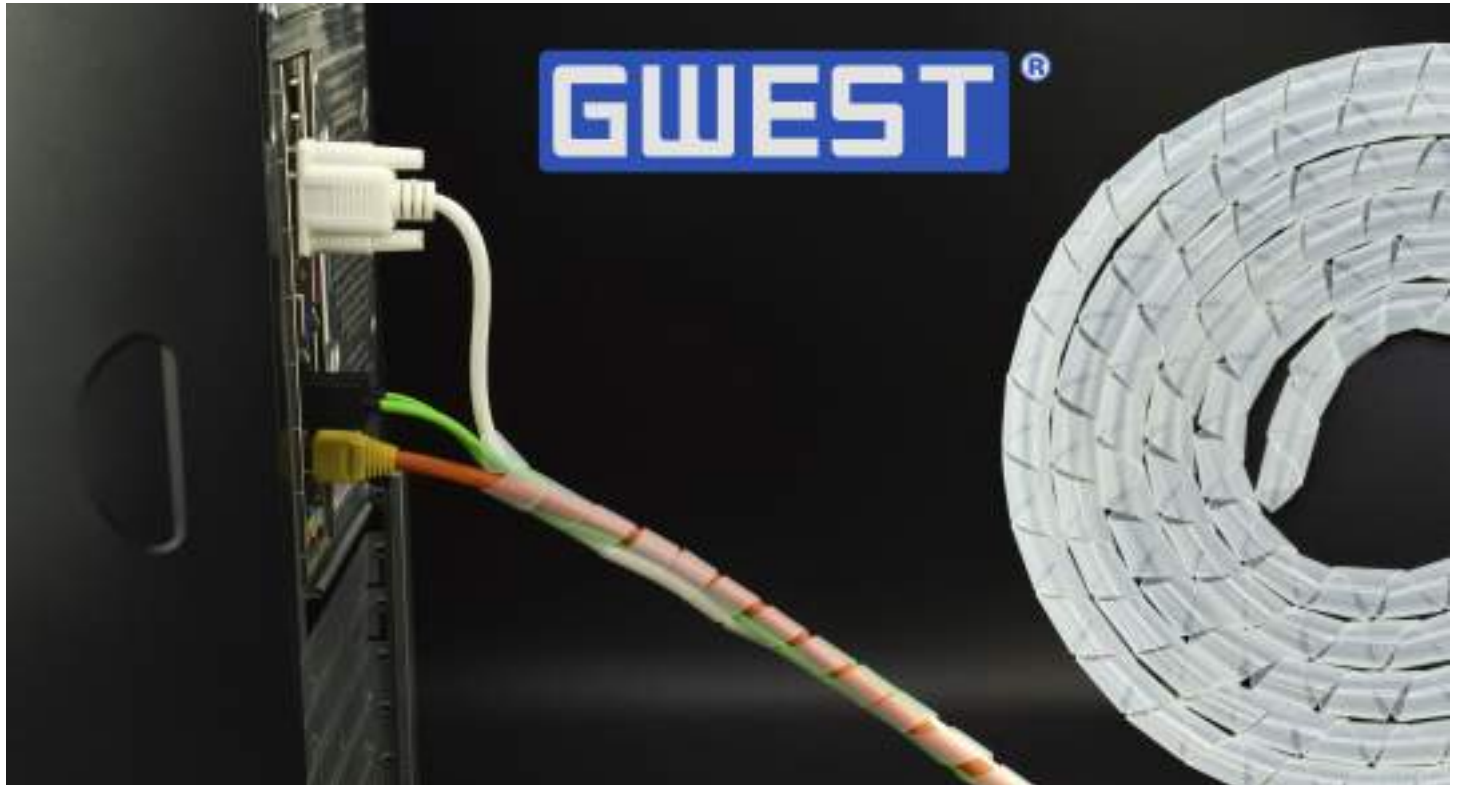
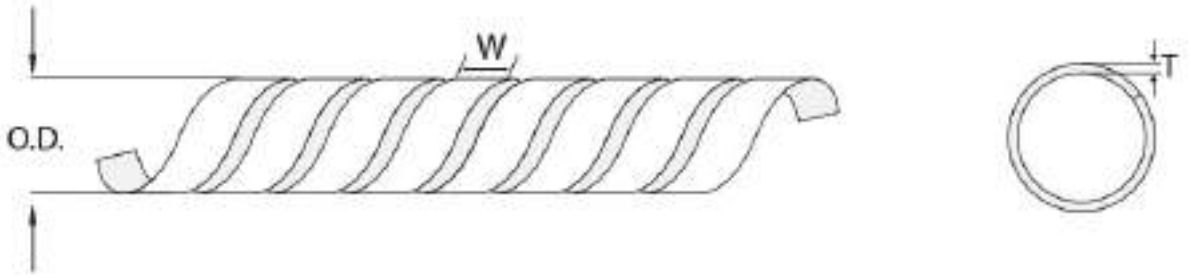



# KABLO YÜKSÜKLERİ

VE KABLO UÇLARI



**TIO**<sup>®</sup>  
OTOMASYON

# İZOLELİ KABLO YÜKSÜKLERİ FRANSIZ NORMU



Standart : DIN 46228  
 Malzeme : Bakır, Kalay Kaplı  
 İzolasyon : Naylon  
 Çalışma Sıcaklığı : Maksimum 105° 600Volt Arası

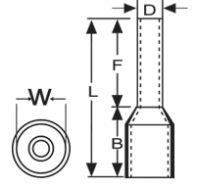

Sipariş Kodu	Ürün Kodu	Renk	Kablo Kesit (mm <sup>2</sup> )	Ebatlar (mm)					Kutu Adet	Birim Fiyat TL / Adet
				F	L	W	B	D		
2001	IYF - 0.25	Menekşe	0.25 mm <sup>2</sup>	8.0	12.0	1.9	4.4	1.1	1.000	<b>0.230</b>
2002	IYF - 0.34	Pembe	0.34 mm <sup>2</sup>	8.0	12.0	1.9	4.4	1.1	1.000	<b>0.230</b>
2003	IYF - 0.50	Beyaz	0.50 mm <sup>2</sup>	8.0	14.0	2.6	6.0	1.3	1.000	<b>0.123</b>
2004	IYF - 0.75	Mavi	0.75 mm <sup>2</sup>	8.0	14.0	2.8	6.3	1.5	1.000	<b>0.123</b>
2005	IYF - 1.0	Kırmızı	1.00 mm <sup>2</sup>	8.0	14.0	3.0	6.3	1.7	1.000	<b>0.123</b>
2006	IYF - 1.5	Siyah	1.50 mm <sup>2</sup>	8.0	14.0	3.5	6.3	2.0	1.000	<b>0.135</b>
2007	IYF - 2.5	Gri	2.50 mm <sup>2</sup>	8.0	14.0	4.2	7.4	2.5	500	<b>0.175</b>
2008	IYF - 4.0	Turuncu	4.00 mm <sup>2</sup>	10.0	17.0	4.8	7.4	3.2	500	<b>0.290</b>
2009	IYF - 6.0	Yeşil	6.00 mm <sup>2</sup>	12.0	20.0	6.3	8.5	3.9	250	<b>0.390</b>
2010	IYF - 10.0	Kahve	10.0 mm <sup>2</sup>	12.0	22.0	7.6	8.8	4.9	100	<b>0.490</b>
2011	IYF - 16.0	Bej	16.0 mm <sup>2</sup>	12.0	24.0	8.8	10.0	6.2	100	<b>0.700</b>
2012	IYF - 25.0	Siyah	25.0 mm <sup>2</sup>	16.0	28.0	11.2	12.0	7.7	50	<b>1.200</b>
2013	IYF - 35.0	Kırmızı	35.0 mm <sup>2</sup>	16.0	30.0	12.7	14.0	8.7	50	<b>1.450</b>
2014	IYF - 50.0	Mavi	50.0 mm <sup>2</sup>	20.0	36.0	15.0	16.0	10.9	25	<b>2.800</b>
2015	IYF - 70.0	Sarı	70.0 mm <sup>2</sup>	21.0	37.0	16.0	17.0	14.3	25	<b>5.300</b>



## İZOLELİ KABLO YÜKSÜKLERİ ALMAN NORMU



Standart : DIN 46228  
 Malzeme : Bakır, Kalay Kaplı  
 İzolasyon : Naylon  
 Çalışma Sıcaklığı : Maksimum 105° 600Volt Arası

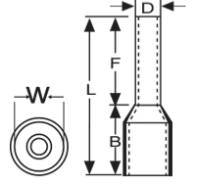

Sipariş Kodu	Ürün Kodu	Renk	Kablo Kesit (mm <sup>2</sup> )	Ebatlar (mm)					Kutu Adet	Birim Fiyat TL / Adet
				F	L	W	B	D		
2101	IYA - 0.14	Gri	0.14 mm <sup>2</sup>	8.0	12.0	1.6	2.8	0.9	1.000	<b>0.230</b>
2102	IYA - 0.25	Mavi	0.25 mm <sup>2</sup>	8.0	12.0	1.9	4.4	1.1	1.000	<b>0.230</b>
2103	IYA - 0.34	Turkuaz	0.34 mm <sup>2</sup>	8.0	12.0	1.9	4.4	1.1	1.000	<b>0.230</b>
2104	IYA - 0.50	Turuncu	0.50 mm <sup>2</sup>	8.0	14.0	2.6	6.0	1.3	1.000	<b>0.123</b>
2105	IYA - 0.75	Beyaz	0.75 mm <sup>2</sup>	8.0	14.0	2.8	6.3	1.5	1.000	<b>0.123</b>
2106	IYA - 1.0	Sarı	1.00 mm <sup>2</sup>	8.0	14.0	3.0	6.3	1.7	1.000	<b>0.123</b>
2107	IYA - 1.5	Kırmızı	1.50 mm <sup>2</sup>	8.0	14.0	3.5	6.3	2.0	1.000	<b>0.135</b>
2108	IYA - 2.5	Mavi	2.50 mm <sup>2</sup>	8.0	14.0	4.2	7.4	2.5	500	<b>0.175</b>
2109	IYA - 4.0	Gri	4.00 mm <sup>2</sup>	10.0	17.0	4.8	7.4	3.2	500	<b>0.290</b>
2110	IYA - 6.0	Siyah	6.00 mm <sup>2</sup>	12.0	20.0	6.3	8.5	3.9	250	<b>0.390</b>
2111	IYA - 10.0	Bej	10.0 mm <sup>2</sup>	12.0	22.0	7.6	8.8	4.9	100	<b>0.490</b>
2112	IYA - 16.0	Yeşil	16.0 mm <sup>2</sup>	12.0	24.0	8.8	10.0	6.2	100	<b>0.700</b>
2113	IYA - 25.0	Kahve	25.0 mm <sup>2</sup>	16.0	28.0	11.2	12.0	7.7	50	<b>1.200</b>
2114	IYA - 35.0	Bej	35.0 mm <sup>2</sup>	16.0	30.0	12.7	14.0	8.7	50	<b>1.450</b>
2115	IYA - 50.0	Yeşil	50.0 mm <sup>2</sup>	20.0	36.0	15.0	16.0	10.9	25	<b>2.800</b>



# ÇİFT GİRİŞLİ KABLO YÜKSÜKLERİ FRANSIZ NORMU



Standart : DIN 46228  
 Malzeme : Bakır, Kalay Kaplı  
 İzolasyon : Naylon  
 Çalışma Sıcaklığı : Maksimum 105° 600Volt Arası

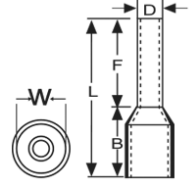

Sipariş Kodu	Ürün Kodu	Renk	Kablo Kesit (mm <sup>2</sup> )	Ebatlar (mm)					Kutu Adet	Birim Fiyat TL / Adet
				F	L	W	B	D		
2201	CYF - 0.50	Beyaz	0.50 mm <sup>2</sup>	8.0	14.0	5.0	6.5	1.8	1.000	0.225
2202	CYF - 0.75	Mavi	0.75 mm <sup>2</sup>	8.0	14.0	5.5	6.7	2.1	500	0.230
2203	CYF - 1.0	Kırmızı	1.00 mm <sup>2</sup>	8.0	14.0	5.5	7.1	2.4	500	0.245
2204	CYF - 1.5	Siyah	1.50 mm <sup>2</sup>	8.0	14.0	6.4	7.5	2.6	500	0.295
2205	CYF - 2.5	Gri	2.50 mm <sup>2</sup>	10.0	14.0	8.0	8.5	3.3	250	0.485
2206	CYF - 4.0	Turuncu	4.00 mm <sup>2</sup>	12.0	17.0	8.0	11.1	4.2	200	0.565
2207	CYF - 6.0	Yeşil	6.00 mm <sup>2</sup>	14.0	20.0	9.5	12.1	5.3	100	0.700
2208	CYF - 10.0	Kahve	10.0 mm <sup>2</sup>	14.0	27.0	12.6	12.6	6.9	50	1.070
2209	CYF - 16.0	Bej	16.0 mm <sup>2</sup>	14.0	31.0	19.0	17.3	8.7	50	1.330









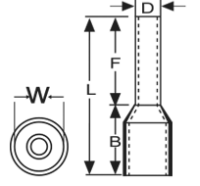

# ÇİFT GİRİŞLİ KABLO YÜKSÜKLERİ ALMAN NORMU



Standart : DIN 46228  
 Malzeme : Bakır, Kalay Kaplı  
 İzolasyon : Naylon  
 Çalışma Sıcaklığı : Maksimum 105° 600Volt Arası



Sipariş Kodu	Ürün Kodu	Renk	Kablo Kesit (mm <sup>2</sup> )	Ebatlar (mm)					Kutu Adet	Birim Fiyat TL / Adet
				F	L	W	B	D		
2301	CYA - 0.50	 Turuncu	0.50 mm <sup>2</sup>	8.0	14.0	5.0	6.5	1.8	1.000	<b>0.225</b>
2302	CYA - 0.75	 Beyaz	0.75 mm <sup>2</sup>	8.0	14.0	5.5	6.7	2.1	500	<b>0.230</b>
2303	CYA - 1.0	 Sarı	1.00 mm <sup>2</sup>	8.0	14.0	5.5	7.1	2.4	500	<b>0.245</b>
2304	CYA - 1.5	 Kırmızı	1.50 mm <sup>2</sup>	8.0	14.0	6.4	7.5	2.6	500	<b>0.295</b>
2305	CYA - 2.5	 Mavi	2.50 mm <sup>2</sup>	10.0	14.0	8.0	8.5	3.3	250	<b>0.485</b>
2306	CYA - 4.0	 Gri	4.00 mm <sup>2</sup>	12.0	17.0	8.0	11.1	4.2	200	<b>0.565</b>
2307	CYA - 6.0	 Siyah	6.00 mm <sup>2</sup>	14.0	20.0	9.5	12.1	5.3	100	<b>0.700</b>
2308	CYA - 10.0	 Bej	10.0 mm <sup>2</sup>	14.0	27.0	12.6	12.6	6.9	50	<b>1.070</b>
2309	CYA - 16.0	 Yeşil	16.0 mm <sup>2</sup>	14.0	31.0	19.0	17.3	8.7	50	<b>1.330</b>



## İZOLESİZ KABLO YÜKSÜKLERİ



Standart : DIN 46228  
Malzeme : Bakır, Kalay Kaplı  
İzolasyon : Yok

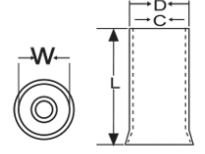

Sipariş Kodu	Ürün Kodu	Kablo Kesit (mm <sup>2</sup> )	Ebatlar (mm)				Kutu Adet	Birim Fiyat TL / Adet
			L	W	D	C		
2401	KY - 0.50	0.50 mm <sup>2</sup>	10	2.1	1.3	1.0	2.000	0.125
2402	KY - 0.75	0.75 mm <sup>2</sup>	10	2.3	1.5	1.2	1.000	0.125
2403	KY - 1.0	1.00 mm <sup>2</sup>	10	2.5	1.7	1.4	1.000	0.125
2404	KY - 1.5	1.50 mm <sup>2</sup>	10	2.8	2.0	1.7	1.000	0.138
2405	KY - 2.5	2.50 mm <sup>2</sup>	12	3.4	2.5	2.2	1.000	0.188
2406	KY - 4.0	4.00 mm <sup>2</sup>	12	4.0	3.2	2.8	1.000	0.258
2407	KY - 6.0	6.00 mm <sup>2</sup>	12	4.7	3.9	3.5	500	0.348
2408	KY - 10.0	10.0 mm <sup>2</sup>	15	5.8	4.9	4.5	250	0.585
2409	KY - 16.0	16.0 mm <sup>2</sup>	15	7.5	6.2	5.8	250	0.725
2410	KY - 25.0	25.0 mm <sup>2</sup>	16	9.1	7.9	7.5	100	1.100
2411	KY - 35.0	35.0 mm <sup>2</sup>	16	10.2	8.7	8.3	100	1.250
2412	KY - 50.0	50.0 mm <sup>2</sup>	22	12.7	10.9	10.3	50	2.600



**GWEST**®

# KABLO UÇLARI



**TIO**®  
OTOMASYON

# YUVARLAK TİP İZOLELİ KABLO UÇLARI



Standart : DIN 46237  
 Malzeme : Bakır, Kalay Kaplı  
 İzolasyon : PVC  
 Çalışma Sıcaklığı : Maksimum 105° 600Volt Arası

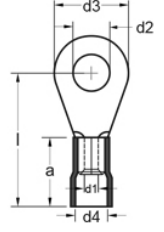

Sipariş Kodu	Ürün Kodu	Renk	Kablo Kesit (mm <sup>2</sup> )	Civata Ölçüsü	Ebatlar (mm)						Kutu Adet	Birim Fiyat TL / Adet
					d2	d3	l	d1	d4	a		
3001	GYU - 301	Kırmızı	0.50 - 1.50 mm <sup>2</sup>	M3	3.2	6.0	16.0	1.6	4.0	10.0	200	0.380
3003	GYU - 401	Kırmızı		M4	4.3	8.0	17.0	1.6	4.0	10.0	200	0.570
3004	GYU - 501	Kırmızı		M5	5.3	10.0	18.0	1.6	4.0	10.0	200	0.580
3005	GYU - 601	Kırmızı		M6	6.5	10.0	18.0	1.6	4.0	10.0	200	0.915
3006	GYU - 801	Kırmızı		M8	8.4	14.0	22.0	1.6	4.0	10.0	200	0.920
3007	GYU - 302	Mavi		1.50 - 2.50 mm <sup>2</sup>	M3	3.2	6.0	16.0	2.3	4.5	10.0	200
3008	GYU - 402	Mavi	M4		4.3	8.0	17.0	2.3	4.5	10.0	200	0.715
3009	GYU - 502	Mavi	M5		5.3	10.0	19.0	2.3	4.5	10.0	200	0.720
3010	GYU - 602	Mavi	M6		6.5	11.0	20.0	2.3	4.5	10.0	200	1.020
3011	GYU - 802	Mavi	M8		8.4	14.0	22.0	2.3	4.5	10.0	200	1.020
3012	GYU - 1002	Mavi	M10		10.5	15.0	22.0	2.3	4.5	10.0	200	1.030
3013	GYU - 406	Sarı	4.00 - 6.00 mm <sup>2</sup>	M4	4.3	8.6	21.0	3.6	6.3	13.0	100	1.500
3014	GYU - 506	Sarı		M5	5.3	10.0	22.0	3.6	6.3	13.0	100	1.500
3015	GYU - 606	Sarı		M6	6.5	11.0	22.5	3.6	6.3	13.0	100	1.680
3016	GYU - 806	Sarı		M8	8.4	14.0	26.0	3.6	6.3	13.0	100	2.170
3017	GYU - 1006	Sarı		M10	10.5	18.0	28.0	3.6	6.3	13.0	100	2.180
3018	GYU - 1206	Sarı		M12	13.0	18.0	28.0	3.6	6.3	13.0	100	2.200
3019	GYU - 610	Kırmızı	8.00 - 10.00 mm <sup>2</sup>	M6	6.7	23.5	30.0	4.5	8.0	17.0	50	2.900
3020	GYU - 810	Kırmızı		M8	8.4	26.3	36.0	4.5	8.0	17.0	50	3.200



# ÇATAL TIP İZOLELİ KABLO UÇLARI



Standart : DIN 46237  
 Malzeme : Bakır, Kalay Kaplı  
 İzolasyon : PVC  
 Çalışma Sıcaklığı : Maksimum 105° 600Volt Arası

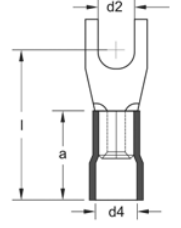

Sipariş Kodu	Ürün Kodu	Renk	Kablo Kesit (mm <sup>2</sup> )	Civata Ölçüsü	Ebatlar (mm)						Kutu Adet	Birim Fiyat TL / Adet
					d2	d3	l	d1	d4	a		
3101	GÇU - 3001	Kırmızı	0.50 - 1.50 mm <sup>2</sup>	M3	3.2	6.0	16.0	1.6	4.0	10.0	200	0.520
3102	GÇU - 4001	Kırmızı		M4	4.3	8.0	17.0	1.6	4.0	10.0	200	0.535
3103	GÇU - 5001	Kırmızı		M5	5.3	10.0	18.0	1.6	4.0	10.0	200	0.555
3104	GÇU - 6001	Kırmızı		M6	6.5	11.0	20.0	1.6	4.0	10.0	200	0.625
3105	GÇU - 3002	Mavi	1.50 - 2.50 mm <sup>2</sup>	M3	3.2	5.5	18.0	2.3	4.5	10.0	200	0.570
3106	GÇU - 4002	Mavi		M4	4.3	6.8	17.0	2.3	4.5	10.0	200	0.590
3107	GÇU - 5002	Mavi		M5	5.3	10.0	19.0	2.3	4.5	10.0	200	0.595
3108	GÇU - 6002	Mavi		M6	6.5	11.0	21.0	2.3	4.5	10.0	200	0.800
3109	GÇU - 4006	Sarı	4.00 - 6.00 mm <sup>2</sup>	M4	4.3	8.0	21.0	3.6	6.3	13.0	100	1.310
3110	GÇU - 5006	Sarı		M5	5.3	10.0	22.0	3.6	6.3	13.0	100	1.330
3111	GÇU - 6006	Sarı		M6	6.5	11.0	23.0	3.6	6.3	13.0	100	1.780
3112	GÇU - 8006	Sarı		M8	8.4	14.0	26.0	3.6	6.3	13.0	100	2.050

## EK MUFLARI İZOLELİ KABLO UÇLARI



Standart : DIN 46237  
 Malzeme : Bakır, Kalay Kaplı  
 İzolasyon : PVC  
 Çalışma Sıcaklığı : Maksimum 75° 600Volt Arası

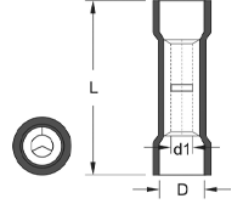

Sipariş Kodu	Ürün Kodu	Renk	Kablo Kesit (mm <sup>2</sup> )	Ebatlar (mm)			Kutu Adet	Birim Fiyat TL / Adet
				L	D	d1		
3201	GBY - 251	Kırmızı	0.50 - 1.50 mm <sup>2</sup>	24.6	4.0	1.7	200	0.800
3202	GBY - 252	Mavi	1.50 - 2.50 mm <sup>2</sup>	24.6	4.5	2.3	200	0.820
3203	GBY - 256	Sarı	4.00 - 6.00 mm <sup>2</sup>	26.5	6.3	3.4	100	1.350

## ERKEK TERMİNALLER İZOLELİ KABLO UÇLARI



Malzeme : Pirinç, Kalay Kaplı, Bakır Yüksüklü  
 İzolasyon : PVC  
 Çalışma Sıcaklığı : Maksimum 75° 600Volt Arası

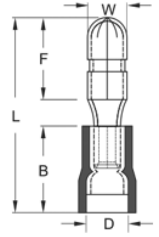

Sipariş Kodu	Ürün Kodu	Renk	Kablo Kesit (mm <sup>2</sup> )	Ebatlar (mm)					Kutu Adet	Birim Fiyat TL / Adet
				W	F	L	B	D		
3204	GBE - 1040	Kırmızı	0.50 - 1.50 mm <sup>2</sup>	4.0	8.5	21.5	10.5	3.8	200	1.360
3205	GBE - 2050	Mavi	1.50 - 2.50 mm <sup>2</sup>	5.0	8.5	21.2	10.5	4.7	200	1.530
3206	GBE - 5050	Sarı	4.00 - 6.00 mm <sup>2</sup>	5.0	8.5	24.0	13.0	6.2	200	2.070

## DIŞI TERMİNALLER İZOLELİ KABLO UÇLARI



Malzeme : Pirinç, Kalay Kaplı, Bakır Yüksüklü  
 İzolasyon : PVC  
 Çalışma Sıcaklığı : Maksimum 75° 600Volt Arası

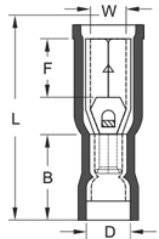

Sipariş Kodu	Ürün Kodu	Renk	Kablo Kesit (mm <sup>2</sup> )	Ebatlar (mm)					Kutu Adet	Birim Fiyat TL / Adet
				W	F	L	B	D		
3207	GBD - 1040	Kırmızı	0.50 - 1.50 mm <sup>2</sup>	3.9	7.0	23.3	10.5	3.8	200	1.630
3208	GBD - 2050	Mavi	1.50 - 2.50 mm <sup>2</sup>	4.9	7.0	23.3	10.5	4.7	100	1.830
3209	GBD - 5050	Sarı	4.00 - 6.00 mm <sup>2</sup>	4.9	7.0	25.1	12.5	6.2	100	2.250

## DIŞI FASTON TİP İZOLELİ KABLO UÇLARI



Malzeme : Pirinç, Kalay Kaplı  
İzolasyon : PVC  
Çalışma Sıcaklığı : Maksimum 75° 600Volt Arası

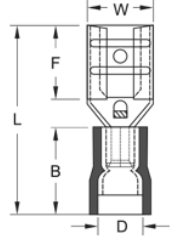

Sipariş Kodu	Ürün Kodu	Renk	Kablo Kesit (mm <sup>2</sup> )	Soket Genişliği	Ebatlar (mm)					Kutu Adet	Birim Fiyat TL / Adet
					W	F	L	B	D		
3210	GFD - 1288	■ Kırmızı	0.50 - 1.50 mm <sup>2</sup>	0.8 x 2.80	3.2	6.5	19.0	10.5	3.8	200	0.450
3211	GFD - 1488	■ Kırmızı		0.8 x 4.75	5.0	6.4	19.4	10.5	3.8	200	0.550
3212	GFD - 1638	■ Kırmızı		0.8 x 6.35	6.6	7.5	20.8	10.5	3.8	200	0.710
3213	GFD - 2288	■ Mavi	1.50 - 2.50 mm <sup>2</sup>	0.8 x 2.80	3.2	6.5	19.0	10.5	4.7	200	0.550
3214	GFD - 2488	■ Mavi		0.8 x 4.75	5.0	6.4	19.4	10.5	4.7	200	0.620
3215	GFD - 2638	■ Mavi		0.8 x 6.35	6.6	7.5	20.8	10.5	4.7	200	0.710
3216	GFD - 5638	■ Sarı	4.00 - 6.00 mm <sup>2</sup>	0.8 x 6.35	6.6	7.5	23.3	13.0	6.2	200	0.870

## TAM İZOLELİ DIŞI FASTON TİP KABLO UÇLARI



Malzeme : Pirinç, Kalay Kaplı  
İzolasyon : PVC  
Çalışma Sıcaklığı : Maksimum 75° 600Volt Arası

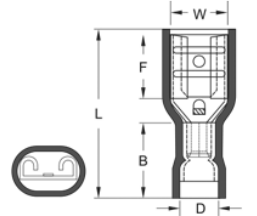

Sipariş Kodu	Ürün Kodu	Renk	Kablo Kesit (mm <sup>2</sup> )	Soket Genişliği	Ebatlar (mm)					Kutu Adet	Birim Fiyat TL / Adet
					W	F	L	B	D		
3218	GFFD - 1288	■ Kırmızı	0.50 - 1.50 mm <sup>2</sup>	0.8 x 2.80	3.2	6.5	19.0	10.5	3.8	200	0.650
3219	GFFD - 1488	■ Kırmızı		0.8 x 4.75	5.0	6.4	20.5	10.5	3.8	200	0.700
3220	GFFD - 1638	■ Kırmızı		0.8 x 6.35	6.6	7.5	21.8	10.5	3.8	200	0.940
3221	GFFD - 2288	■ Mavi	1.50 - 2.50 mm <sup>2</sup>	0.8 x 2.80	3.2	6.5	20.0	10.5	4.7	200	0.700
3222	GFFD - 2488	■ Mavi		0.8 x 4.75	5.0	6.4	20.2	10.5	4.7	200	0.720
3223	GFFD - 2638	■ Mavi		0.8 x 6.35	6.6	7.5	22.2	10.5	4.7	200	0.940
3224	GFFD - 5638	■ Sarı	4.00 - 6.00 mm <sup>2</sup>	0.8 x 6.35	6.6	7.5	24.2	12.5	6.2	100	1.030

## TAM İZOLELİ POLYAMİD DİŞİ FASTON TİP KABLO UÇLARI



Malzeme : Piriç, Kalay Kaplı  
İzolasyon : Polyamid  
Çalışma Sıcaklığı : Maksimum 105° 600Volt Arası

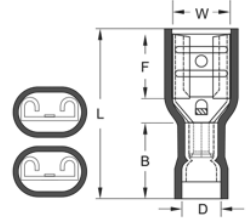

Sipariş Kodu	Ürün Kodu	Renk	Kablo Kesit (mm <sup>2</sup> )	Soket Genişliği	Ebatlar (mm)					Kutu Adet	Birim Fiyat TL / Adet
					W	F	L	B	D		
3225	GPFD - 1638	■ Kırmızı	0.50 - 1.50 mm <sup>2</sup>	0.8 x 6.35	6.6	7.5	21.5	11.0	4.0	200	2.100
3226	GPFD - 2638	■ Mavi	1.50 - 2.50 mm <sup>2</sup>	0.8 x 6.35	6.6	7.5	21.5	11.0	5.0	200	2.100
3227	GPFD - 5638	■ Sarı	4.00 - 6.00 mm <sup>2</sup>	0.8 x 6.35	6.6	7.5	24.2	13.0	6.5	100	2.500

## İĞNE TİP İZOLELİ KABLO UÇLARI



Malzeme : Piriç, Kalay Kaplı  
İzolasyon : PVC  
Çalışma Sıcaklığı : Maksimum 75° 600Volt Arası

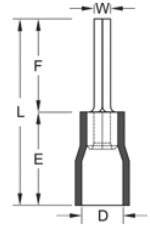

Sipariş Kodu	Ürün Kodu	Renk	Kablo Kesit (mm <sup>2</sup> )	Ebatlar (mm)					Kutu Adet	Birim Fiyat TL / Adet
				W	F	L	E	D		
3228	GİK - 101	■ Kırmızı	0.50 - 1.50 mm <sup>2</sup>	1.9	10.0	19.0	10.0	4.0	200	0.610
3229	GİK - 102	■ Mavi	1.50 - 2.50 mm <sup>2</sup>	1.9	12.0	21.8	10.0	4.5	200	0.720
3230	GİK - 106	■ Sarı	4.00 - 6.00 mm <sup>2</sup>	2.8	14.0	27.0	27.0	6.4	100	1.720

## ERKEK / DİŞİ GERİ DÖNÜŞLÜ TERMİNALLER



Malzeme : Piriç, Kalay Kaplı  
İzolasyon : PVC  
Çalışma Sıcaklığı : Maksimum 75° 600Volt Arası

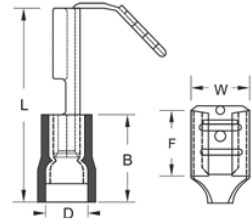

Sipariş Kodu	Ürün Kodu	Renk	Kablo Kesit (mm <sup>2</sup> )	Soket Genişliği	Ebatlar (mm)					Kutu Adet	Birim Fiyat TL / Adet
					W	F	L	B	D		
3231	GFDEG - 1861	■ Kırmızı	0.50 - 1.50 mm <sup>2</sup>	0.8 x 6.35	6.6	8.0	22.5	10.5	3.8	100	1.250
3232	GFDEG - 2862	■ Mavi	1.50 - 2.50 mm <sup>2</sup>	0.8 x 6.35	6.6	8.0	22.5	10.5	4.7	100	1.250
3233	GFDEG - 5866	■ Sarı	4.00 - 6.00 mm <sup>2</sup>	0.8 x 6.35	6.6	8.0	24.0	13.0	6.2	100	1.400

## ERKEK FASTON TİP TERMİNALLER



Malzeme : Pirinç, Kalay Kaplı  
İzolasyon : PVC  
Çalışma Sıcaklığı : Maksimum 75° 600Volt Arası

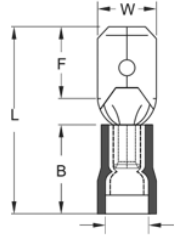

Sipariş Kodu	Ürün Kodu	Renk	Kablo Kesit (mm <sup>2</sup> )	Soket Genişliği	Ebatlar (mm)					Kutu Adet	Birim Fiyat TL / Adet
					W	F	L	B	D		
3236	GFE - 1288	Kırmızı	0.50 - 1.50 mm <sup>2</sup>	0.8 x 2.80	2.8	6.5	19.2	10.5	3.8	200	0.500
3237	GFE - 1488	Kırmızı		0.8 x 4.75	4.8	6.7	19.8	10.5	3.8	200	0.500
3238	GFE - 1638	Kırmızı		0.8 x 6.35	6.35	6.35	21.8	10.5	3.8	200	0.590
3239	GFE - 2288	Mavi	1.50 - 2.50 mm <sup>2</sup>	0.8 x 2.80	2.8	6.7	19.8	10.5	4.7	200	0.500
3240	GFE - 2488	Mavi		0.8 x 4.75	4.8	6.7	19.8	10.5	4.7	200	0.500
3241	GFE - 2638	Mavi		0.8 x 6.35	6.35	7.7	21.8	10.5	4.7	200	0.650
3242	GFE - 5638	Sarı	4.00 - 6.00 mm <sup>2</sup>	0.8 x 6.35	6.35	7.7	24.8	13.0	6.2	200	0.770

## TAM İZOLELİ POLYAMİD BAYRAK TİP TERMİNALLER





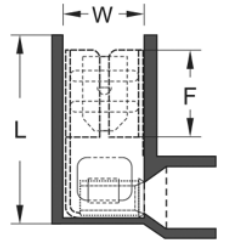





















Malzeme : Pirinç, Kalay Kaplı  
İzolasyon : Polyamid  
Çalışma Sıcaklığı : Maksimum 105° 600Volt Arası



Sipariş Kodu	Ürün Kodu	Renk	Kablo Kesit (mm <sup>2</sup> )	Soket Genişliği	Ebatlar (mm)			Kutu Adet	Birim Fiyat TL / Adet
					W	F	L		
3234	GPFDEB - 1861	Kırmızı	0.50 - 1.50 mm <sup>2</sup>	0.8 x 6.35	6.6	7.6	16.0	100	1.550
3235	GPFDEB - 2862	Mavi	1.50 - 2.50 mm <sup>2</sup>	0.8 x 6.35	6.6	7.6	16.0	100	1.550

## İZOLESİZ KABLO UCU VE KONNEKTÖRLERİ

					
<b>SİPARİŞ KODU</b>	3301	3302	3303	3305	3304
<b>ÜRÜN KODU</b>	GF1/2D	GF1D MİNİ	GF1D	GF3D	GF2D TRK
<b>AÇIKLAMA</b>	2.8 Mikro Dişi Terminal	4.8 Mini Dişi Terminal	6.3 Dişi Terminal	9.5 Dişi Terminal	6.3 Tırnaklı Dişi Terminal
<b>KUTU ADET</b>	1.000	500	300	100	300
<b>BİRİM FİYAT TL/Ad.</b>	<b>0.230</b>	<b>0.320</b>	<b>0.450</b>	<b>1.050</b>	<b>0.450</b>
					
<b>SİPARİŞ KODU</b>	3306	3307	3320	3321	3309
<b>ÜRÜN KODU</b>	GF1D EĞRİ	GF1D E	GKN 1-03	GKN 1-04	GKN 2.5-04
<b>AÇIKLAMA</b>	6.3 Eğri Dişi Terminal	6.3 Erkek Geri Dönüşümlü Terminal	M3 Topraklama Terminali	M4 Topraklama Terminali	M4 Topraklama Terminali
<b>KUTU ADET</b>	250	200	500	500	500
<b>BİRİM FİYAT TL/Ad.</b>	<b>0.520</b>	<b>0.850</b>	<b>0.360</b>	<b>0.360</b>	<b>0.360</b>
					
<b>SİPARİŞ KODU</b>	3310	3311	3312	3313	3314
<b>ÜRÜN KODU</b>	GKN 2.5-05	GKN 2.5-06	GKN 4-04	GKN 4-05	GKN 4-06
<b>AÇIKLAMA</b>	M5 Topraklama Terminali	M6 Topraklama Terminali	M4 Topraklama Terminali	M5 Topraklama Terminali	M6 Topraklama Terminali
<b>KUTU ADET</b>	500	500	250	250	250
<b>BİRİM FİYAT TL/Ad.</b>	<b>0.360</b>	<b>0.360</b>	<b>0.860</b>	<b>0.860</b>	<b>0.860</b>
					
<b>SİPARİŞ KODU</b>	3315	3316	3318	3325	3326
<b>ÜRÜN KODU</b>	GKN 6-06	GKN 8-08	GKN 10-10	GK 2.5	GK 4
<b>AÇIKLAMA</b>	M6 Topraklama Terminali	M8 Topraklama Terminali	M10 Topraklama Terminali	Boru Tip Topraklama Terminali	Boru Tip Topraklama Terminali
<b>KUTU ADET</b>	150	150	100	1.000	500
<b>BİRİM FİYAT TL/Ad.</b>	<b>1.100</b>	<b>1.100</b>	<b>1.350</b>	<b>0.440</b>	<b>0.740</b>
					
<b>SİPARİŞ KODU</b>	3327	3332	3333	3341	3340
<b>ÜRÜN KODU</b>	GK 6	GF1E ÇK	GF1EU1	R TİPİ KONNEKTÖR	GF1D KILIF
<b>AÇIKLAMA</b>	Boru Tip Topraklama Terminali	6.3 Erkek Terminal	6.3 Uzun Erkek Terminal	6.3 Kilitli Konnektör	6.3 Terminal Kılıfı
<b>KUTU ADET</b>	250	300	300	300	300
<b>BİRİM FİYAT TL/Ad.</b>	<b>0.800</b>	<b>0.440</b>	<b>0.570</b>	<b>0.270</b>	<b>0.190</b>

# İMALATLARIMIZ

SIKMALI KABLO PABUÇLARI  
MONTAJ RAYLARI  
W OTOMAT BARALARI  
U KLEMENSLER



**TIO**<sup>®</sup>  
OTOMASYON

**YERLİ  
ÜRETİM**

## SKP EKO TİP KABLO PABUCU

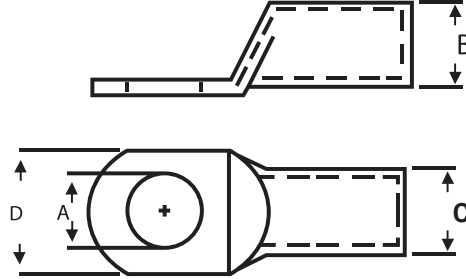

### Gwest Eko Tip Kablo Pabuçlarımız;

- \* EN/13600 standartlarında bakır malzemeden imal edilmiştir.
- \* Sıkma işlemi yapılırken kırılmayı, sıkma işlemi sonrasında gevşemeyi önlemek için üretim esnasında **tavlı bakır borular** kullanılmıştır.
- \* Üretimde **%99.9** oranında iletkenliğe sahip bakır kullanılmıştır.
- \* **5-8 Micron** aralığında **100% Kalay** kaplama yapılmaktadır.

Sipariş Kodu	Ürün Kodu	Kablo Kesit (mm <sup>2</sup> )	Delik Çapı Ø	Boyutlar				Kutu Adet	Birim Fiyat TL / Adet
				A	B	C	D		
3400	SKP-E 16-6	16 mm <sup>2</sup>	M6	6,4	5,5	7,0	10,5	500	3.50
3401	SKP-E 16-8		M8	8,3	5,5	7,0	12,0	500	3.50
3402	SKP-E 25-6	25 mm <sup>2</sup>	M6	6,5	7,0	9,0	13,0	400	7.20
3403	SKP-E 25-8		M8	8,3	7,0	9,0	13,0	400	7.20
3404	SKP-E 35-6	35 mm <sup>2</sup>	M6	6,5	8,5	10,5	15,5	300	9.50
3405	SKP-E 35-8		M8	8,3	8,5	10,5	15,5	300	9.50
3406	SKP-E 50-8	50 mm <sup>2</sup>	M8	8,2	10,0	12,0	17,6	200	12.50
3407	SKP-E 50-10		M10	10,3	10,0	12,0	17,9	200	12.50
3408	SKP-E 70-10	70 mm <sup>2</sup>	M10	10,3	11,5	14,0	20,7	100	19.30
3409	SKP-E 70-12		M12	13,0	11,5	14,0	20,7	100	19.30



## SKP EKO TİP KABLO PABUCU

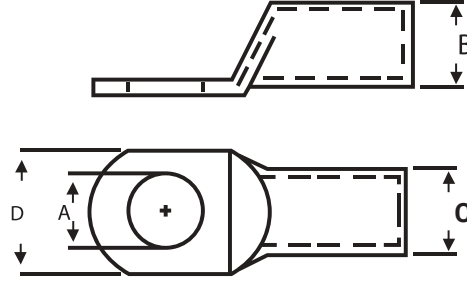

## Gwest Eko Tip Kablo Pabuçlarımız;

- \* EN/13600 standartlarında bakır malzemeden imal edilmiştir.
- \* Sıkma işlemi yapılırken kırılmayı, sıkma işlemi sonrasında gevşemeyi önlemek için üretim esnasında **tavlı bakır borular** kullanılmıştır.
- \* Üretimde %99.9 oranında iletkenliğe sahip bakır kullanılmıştır.
- \* 5-8 Micron aralığında **100% Kalay** kaplama yapılmaktadır.

Sipariş Kodu	Ürün Kodu	Kablo Kesit (mm <sup>2</sup> )	Delik Çapı Ø	Boyutlar				Kutu Adet	Birim Fiyat TL / Adet
				A	B	C	D		
3410	SKP-E 95-10	95 mm <sup>2</sup>	M10	10,3	13,5	16,0	23,5	75	24.00
3411	SKP-E 95-12		M12	12,8	13,5	16,0	23,5	75	24.00
3412	SKP-E 120-10	120 mm <sup>2</sup>	M10	10,5	15,5	18,0	26,7	50	34.00
3413	SKP-E 120-12		M12	12,8	15,5	18,0	26,7	50	34.00
3414	SKP-E 150-10	150 mm <sup>2</sup>	M10	10,5	16,5	20,0	29,2	40	51.00
3415	SKP-E 150-12		M12	12,8	16,5	20,0	29,2	40	51.00
3416	SKP-E 185-12	185 mm <sup>2</sup>	M12	10,5	18,5	22,0	32,3	30	63.00
3417	SKP-E 185-16		M16	16,5	18,5	22,0	32,3	30	63.00
3418	SKP-E 240-12	240 mm <sup>2</sup>	M12	13,0	21,5	25,5	37,6	25	95.00
3419	SKP-E 240-16		M16	16,5	21,5	25,5	37,6	25	95.00

## SKP STANDART TİP KABLO PABUCU

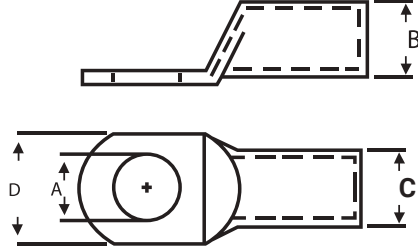

### Gwest Standart Tip Kablo Pabuçlarımız;

- \* EN/13600 standartlarında bakır malzemeden imal edilmiştir.
- \* Sıkma işlemi yapılırken kırılmayı, sıkma işlemi sonrasında gevşemeyi önlemek için üretim esnasında **tavlı bakır borular** kullanılmıştır.
- \* Üretimde **%99.9** oranında iletkenliğe sahip bakır kullanılmıştır.
- \* **5-8 Micron** aralığında **100% Kalay** kaplama yapılmaktadır.

Sipariş Kodu	Ürün Kodu	Kablo Kesit (mm <sup>2</sup> )	Delik Çapı Ø	Boyutlar				Kutu Adet	Birim Fiyat TL / Adet
				A	B	C	D		
<b>3430</b>	<b>SKP-S 10-5</b>	<b>10 mm<sup>2</sup></b>	<b>M5</b>	<b>5,5</b>	<b>4,7</b>	<b>6,6</b>	<b>10,3</b>	<b>1.000</b>	<b>3.50</b>
3431	SKP-S 10-6		M6	6,5	4,7	6,6	10,3	1.000	3.50
3432	SKP-S 10-8		M8	8,5	4,7	6,6	13,5	1.000	3.50
3390	SKP-S 16-5	<b>16 mm<sup>2</sup></b>	M5	5,5	5,6	7,8	11,2	500	5.00
<b>3433</b>	<b>SKP-S 16-6</b>		<b>M6</b>	<b>6,5</b>	<b>5,6</b>	<b>7,8</b>	<b>11,2</b>	<b>500</b>	<b>5.00</b>
3434	SKP-S 16-8		M8	8,5	5,6	7,8	13,5	500	5.50
3435	SKP-S 16-10		M10	10,5	5,6	7,8	16,0	500	5.50
3436	SKP-S 25-6	<b>25 mm<sup>2</sup></b>	M6	6,5	7,5	9,5	13,7	400	9.50
<b>3437</b>	<b>SKP-S 25-8</b>		<b>M8</b>	<b>8,5</b>	<b>7,1</b>	<b>9,5</b>	<b>13,7</b>	<b>400</b>	<b>9.50</b>
3438	SKP-S 25-10		M10	10,5	7,1	9,5	16,0	300	9.70
3439	SKP-S 35-6	<b>35 mm<sup>2</sup></b>	M6	6,5	8,2	10,8	15,3	200	12.60
3440	<b>SKP-S 35-8</b>		<b>M8</b>	<b>8,5</b>	<b>8,2</b>	<b>10,8</b>	<b>15,3</b>	<b>200</b>	<b>12.60</b>
3441	<b>SKP-S 35-10</b>		<b>M10</b>	<b>10,5</b>	<b>8,2</b>	<b>10,8</b>	<b>15,7</b>	<b>200</b>	<b>14.00</b>
3391	SKP-S 35-12		M12	13,0	8,2	10,8	18,0	150	14.00
3389	SKP-S 50-6	<b>50 mm<sup>2</sup></b>	M6	6,5	10,1	13,0	18,9	150	18.00
3442	SKP-S 50-8		M8	8,5	10,1	13,0	18,9	150	18.00
3443	<b>SKP-S 50-10</b>		<b>M10</b>	<b>10,5</b>	<b>10,1</b>	<b>13,0</b>	<b>18,9</b>	<b>150</b>	<b>20.00</b>
3444	SKP-S 50-12		M12	13,0	10,1	13,0	18,9	150	20.00
3446	SKP-S 70-8	<b>70 mm<sup>2</sup></b>	M8	8,5	11,5	14,7	21,1	100	26.00
3447	<b>SKP-S 70-10</b>		<b>M10</b>	<b>10,5</b>	<b>11,5</b>	<b>14,7</b>	<b>21,1</b>	<b>100</b>	<b>26.00</b>
3448	SKP-S 70-12		M12	13,0	11,5	14,7	21,1	100	26.00
3449	SKP-S 70-14		M14	15,0	11,5	14,7	21,5	100	30.00
3392	SKP-S 70-16		M16	17,0	11,5	14,7	21,5	100	30.00

## SKP STANDART TİP KABLO PABUCU

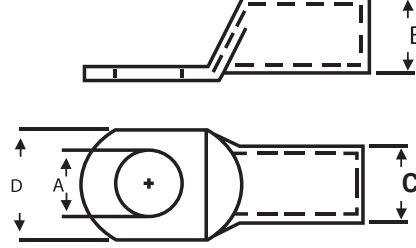

## Gwest Standart Tip Kablo Pabuçlarımız;

- \* EN/13600 standartlarında bakır malzemeden imal edilmiştir.
- \* Sıkma işlemi yapılırken kırılmayı, sıkma işlemi sonrasında gevşemeyi önlemek için üretim esnasında **tavlı bakır borular** kullanılmıştır.
- \* Üretimde **%99.9** oranında iletkenliğe sahip bakır kullanılmıştır.
- \* **5-8 Micron** aralığında **100% Kalay** kaplama yapılmaktadır.

Sipariş Kodu	Ürün Kodu	Kablo Kesit (mm <sup>2</sup> )	Delik Çapı Ø	Boyutlar				Kutu Adet	Birim Fiyat TL / Adet
				A	B	C	D		
3450	SKP-S 95-8	95 mm <sup>2</sup>	M8	8,5	13,5	16,7	24,7	75	32.00
<b>3451</b>	<b>SKP-S 95-10</b>		<b>M10</b>	<b>10,5</b>	<b>13,5</b>	<b>16,7</b>	<b>24,7</b>	<b>75</b>	<b>32.00</b>
<b>3452</b>	<b>SKP-S 95-12</b>		<b>M12</b>	<b>13,0</b>	<b>13,5</b>	<b>16,7</b>	<b>24,7</b>	<b>75</b>	<b>32.00</b>
3453	SKP-S 120-10	120 mm <sup>2</sup>	M10	10,5	15,5	19,0	27,7	50	44.00
<b>3454</b>	<b>SKP-S 120-12</b>		<b>M12</b>	<b>13,0</b>	<b>15,6</b>	<b>19,0</b>	<b>27,7</b>	<b>50</b>	<b>44.00</b>
3393	SKP-S 120-14		M14	15,0	15,6	19,0	27,7	50	49.00
3455	SKP-S 120-16	M16	17,0	15,6	19,0	27,7	50	49.00	
3456	SKP-S 150-10	150 mm <sup>2</sup>	M10	10,5	16,5	21,0	30,4	40	68.00
<b>3457</b>	<b>SKP-S 150-12</b>		<b>M12</b>	<b>13,0</b>	<b>16,5</b>	<b>21,0</b>	<b>30,4</b>	<b>40</b>	<b>68.00</b>
3394	SKP-S 150-14		M14	15,0	16,5	21,0	30,4	40	68.00
3458	SKP-S 150-16	M16	17,0	16,5	21,0	34,0	40	68.00	
3395	SKP-S 185-10	185 mm <sup>2</sup>	M10	10,5	18,4	23,0	34,2	30	88.00
3459	SKP-S 185-12		M12	13,0	18,4	23,0	34,2	30	88.00
3396	SKP-S 185-14		M14	15,0	18,4	23,0	34,2	30	88.00
<b>3460</b>	<b>SKP-S 185-16</b>	<b>M16</b>	<b>17,0</b>	<b>18,4</b>	<b>23,0</b>	<b>34,2</b>	<b>30</b>	<b>88.00</b>	
3397	SKP-S 240-10	240 mm <sup>2</sup>	M10	10,5	21,0	26,0	38,7	25	115.00
3461	SKP-S 240-12		M12	13,0	21,0	26,0	38,7	25	115.00
3398	SKP-S 240-14		M14	15,0	21,0	26,0	38,7	25	115.00
<b>3462</b>	<b>SKP-S 240-16</b>	<b>M16</b>	<b>17,0</b>	<b>21,0</b>	<b>26,0</b>	<b>38,7</b>	<b>25</b>	<b>115.00</b>	
3399	SKP-S 300-12	300 mm <sup>2</sup>	M12	13,0	23,4	28,6	42,6	20	140.00
3463	SKP-S 300-14		M14	15,0	23,4	28,6	42,6	20	140.00
<b>3464</b>	<b>SKP-S 300-16</b>		<b>M16</b>	<b>17,0</b>	<b>23,4</b>	<b>28,6</b>	<b>42,6</b>	<b>20</b>	<b>140.00</b>

## EK MUFLARI



## Gwest Ekmuflarımız;

- \* EN/13600 standartlarında bakır malzemedan imal edilmiştir.
- \* Sıkma işlemi yapılırken kırılmayı, sıkma işlemi sonrasında gevşemeyi önlemek için üretim esnasında **tavlı bakır borular** kullanılmıştır.
- \* Üretimde **%99.9** oranında iletkenliğe sahip bakır kullanılmıştır.
- \* **5-8 Micron** aralığında **100% Kalay** kaplama yapılmaktadır.

Sipariş Kodu	Ürün Kodu	Kablo Kesit (mm <sup>2</sup> )	Boyutlar			Kutu Adet	Birim Fiyat TL / Adet
			A	B	C		
3465	EKMUF - 10	10	4.7	6.6	30.0	1.000	3.40
3466	EKMUF - 16	16	5.5	7.0	35.0	500	3.50
3467	EKMUF - 25	25	7.0	9.0	40.0	300	7.00
3468	EKMUF - 35	35	8.5	10.5	45.0	200	9.50
3469	EKMUF - 50	50	10.0	12.0	50.0	100	12.30
3470	EKMUF - 70	70	11.5	14.0	55.0	75	18.50
3471	EKMUF - 95	95	13.5	16.0	60.0	50	23.00
3472	EKMUF - 120	120	15.5	18.0	65.0	50	33.80
3473	EKMUF - 150	150	16.5	20.0	70.0	30	50.00
3474	EKMUF - 185	185	18.5	22.0	75.0	25	64.00
3475	EKMUF - 240	240	21.5	25.5	85.0	20	90.00
3492	EKMUF - 300	300	23.5	28.5	100.0	15	130.00

## U KLEMENS

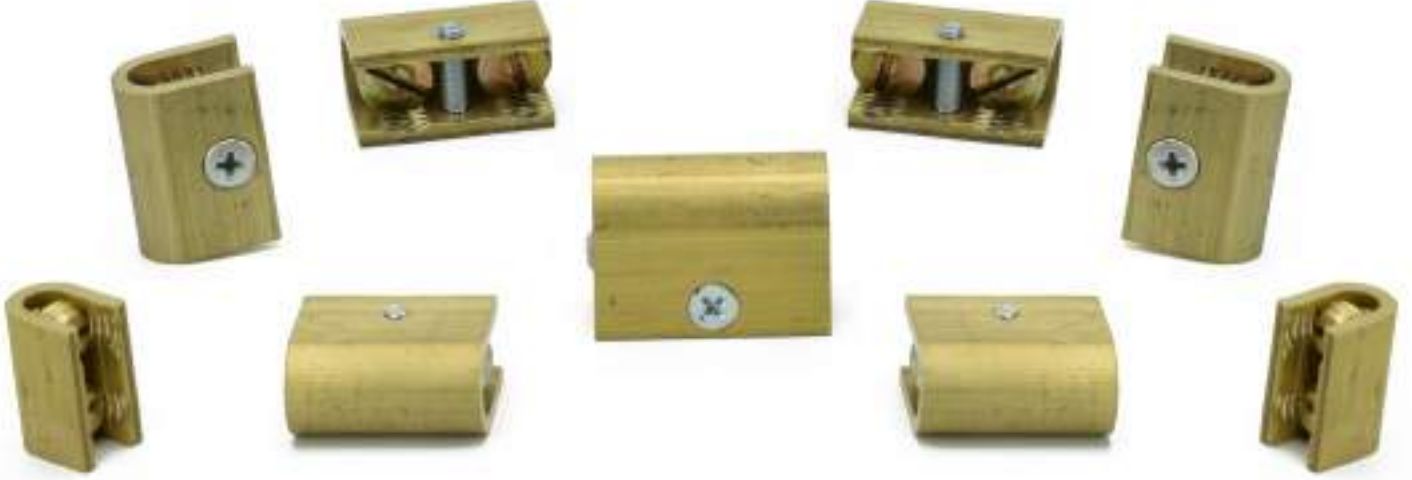

Sipariş Kodu	Ürün Kodu	Açıklama	Kutu Adet	Birim Fiyat TL / Adet
3480	U 6	6mm U Klemens	150	9.70
3481	U 10	10mm U Klemens	125	13.50
3482	U 16	16mm U Klemens	100	19.50
3483	U 25	25mm U Klemens	100	23.50
3484	U 35	35mm U Klemens	75	28.00
3485	U 50	50mm U Klemens	50	45.00
3486	U 70	70mm U Klemens	40	62.00
3487	U 95	95mm U Klemens	25	80.00
3488	U 120	120mm U Klemens	20	108.00
3489	U 150	150mm U Klemens	15	143.00

## DELİKLİ MONTAJ RAYLARI



Malzeme : Galvaniz Kaplama  
Genişlik : 35mm  
Derinlik : 7,5mm



Sipariş Kodu	Ürün Kodu	Uzunluk	Kutu Adet	Birim Fiyat TL / Adet
3494	GW - MR 030	30 cm	150	8.00
3495	GW - MR 1	1 m	50	22.00
3496	GW - MR 2	2 m	30	44.00

## DÜZ MONTAJ RAYLARI



Malzeme : Galvaniz Kaplama  
Genişlik : 35mm  
Derinlik : 7,5mm



Sipariş Kodu	Ürün Kodu	Uzunluk	Kutu Adet	Birim Fiyat TL / Adet
3497	GW - MRD 030	30 cm	150	8.00
3498	GW - MRD 1	1 m	50	22.00
3499	GW - MRD 2	2 m	30	44.00

## MONOFAZE MÜŞTEREK W OTOMAT BARALARI



Sipariş Kodu	Ürün Kodu	Bakır Kalınlığı	Boy	Modül	Amper	Kutu Adet	Fiyat TL / Adet
3601	M - 531	1 mm	53 cm	30 Otomat için	80 A	60	65.00
3602	M - 1061	1 mm	106 cm	60 Otomat için	80 A	60	130.00
3603	M - 5315	1.5 mm	53 cm	30 Otomat için	100 A	60	100.00
3604	M - 10615	1.5 mm	106 cm	60 Otomat için	100 A	60	200.00

## TRİFAZE MÜŞTEREK W OTOMAT BARALARI



Sipariş Kodu	Ürün Kodu	Bakır Kalınlığı	Boy	Modül	Amper	Kutu Adet	Fiyat TL / Adet
3605	T - 221	1 mm	22 cm	4 Grup için	80 A		
3606	T - 331	1 mm	33 cm	6 Grup için	80 A		
3607	T - 441	1 mm	44 cm	8 Grup için	80 A		
3608	T - 531	1 mm	53 cm	10 Grup için	80 A	24	180.00
3609	T - 1061	1 mm	106 cm	20 Grup için	80 A	24	360.00
3610	T - 2215	1,5 mm	22 cm	4 Grup için	100 A		
3611	T - 3315	1,5 mm	33 cm	6 Grup için	100 A		
3612	T - 4415	1,5 mm	44 cm	8 Grup için	100 A		
3613	T - 5315	1,5 mm	53 cm	10 Grup için	100 A	24	270.00
3614	T - 10615	1,5 mm	106 cm	20 Grup için	100 A	24	540.00
3615	Gwest - KAP			Bara Kapağı		500	1.80

İSTEDİĞİNİZ ÖLÇÜDE KESİM YAPILIR.

## 2 KUTUPLU DAĞITICI ÜNİTELER

Birim Fiyat TL / Adet	<b>85.00</b>	
SİPARİŞ KODU	3701	
ÜRÜN KODU	<b>GW - 2x7</b>	
AKIM	125 Amper	
KABLO CİNSİ	Tek Damar	Çok Telli
KABLO KESİTİ (mm <sup>2</sup> )	<b>Giriş</b>	<b>Çıkış</b>
	1x10-35 mm <sup>2</sup>	1x10-25 mm <sup>2</sup> 5x2,5-6 mm <sup>2</sup>
	1x10-16 mm <sup>2</sup>	1x6-16 mm <sup>2</sup> 5x1,5-6 mm <sup>2</sup>
Ambalaj Adet	<b>Paket</b>	<b>Koli</b>
	1	138



Birim Fiyat TL / Adet	<b>117.00</b>	
SİPARİŞ KODU	3702	
ÜRÜN KODU	<b>GW - 2x11</b>	
AKIM	125 Amper	
KABLO CİNSİ	Tek Damar	Çok Telli
KABLO KESİTİ (mm <sup>2</sup> )	<b>Giriş</b>	<b>Çıkış</b>
	2x10-35 mm <sup>2</sup>	2x10-25 mm <sup>2</sup> 7x2,5-6 mm <sup>2</sup>
	2x10-16 mm <sup>2</sup>	2x6-16 mm <sup>2</sup> 7x1,5-6 mm <sup>2</sup>
Ambalaj Adet	<b>Paket</b>	<b>Koli</b>
	1	84



Birim Fiyat TL / Adet	<b>153.00</b>	
SİPARİŞ KODU	3703	
ÜRÜN KODU	<b>GW - 2x15</b>	
AKIM	125 Amper	
KABLO CİNSİ	Tek Damar	Çok Telli
KABLO KESİTİ (mm <sup>2</sup> )	<b>Giriş</b>	<b>Çıkış</b>
	2x10-35 mm <sup>2</sup>	2x10-25 mm <sup>2</sup> 11x2,5-6 mm <sup>2</sup>
	2x10-16 mm <sup>2</sup>	2x6-16 mm <sup>2</sup> 11x1,5-6 mm <sup>2</sup>
Ambalaj Adet	<b>Paket</b>	<b>Koli</b>
	1	72





## 4 KUTUPLU DAĞITICI ÜNİTELER



Birim Fiyat TL / Adet	154.00	
SİPARİŞ KODU	3704	
ÜRÜN KODU	GW - 4x7	
AKIM	125 Amper	
KABLO CİNSİ	Tek Damar	Çok Telli
KABLO KESİTİ (mm <sup>2</sup> )	<b>Giriş</b>	<b>Çıkış</b>
	1x10-35 mm <sup>2</sup>	1x10-25 mm <sup>2</sup> 5x2,5-6 mm <sup>2</sup>
	1x10-16 mm <sup>2</sup>	1x6-16 mm <sup>2</sup> 5x1,5-6 mm <sup>2</sup>
Ambalaj Adet	<b>Paket</b>	<b>Koli</b>
	1	74



Birim Fiyat TL / Adet	220.00	
SİPARİŞ KODU	3705	
ÜRÜN KODU	GW - 4x11	
AKIM	125 Amper	
KABLO CİNSİ	Tek Damar	Çok Telli
KABLO KESİTİ (mm <sup>2</sup> )	<b>Giriş</b>	<b>Çıkış</b>
	2x10-35 mm <sup>2</sup>	2x10-25 mm <sup>2</sup> 7x2,5-6 mm <sup>2</sup>
	2x10-16 mm <sup>2</sup>	2x6-16 mm <sup>2</sup> 7x1,5-6 mm <sup>2</sup>
Ambalaj Adet	<b>Paket</b>	<b>Koli</b>
	1	50



Birim Fiyat TL / Adet	280.00	
SİPARİŞ KODU	3706	
ÜRÜN KODU	GW - 4x15	
AKIM	125 Amper	
KABLO CİNSİ	Tek Damar	Çok Telli
KABLO KESİTİ (mm <sup>2</sup> )	<b>Giriş</b>	<b>Çıkış</b>
	2x10-35 mm <sup>2</sup>	2x10-25 mm <sup>2</sup> 11x2,5-6 mm <sup>2</sup>
	2x10-16 mm <sup>2</sup>	2x6-16 mm <sup>2</sup> 11x1,5-6 mm <sup>2</sup>
Ambalaj Adet	<b>Paket</b>	<b>Koli</b>
	1	40



Birim Fiyat TL / Adet	680.00	
SİPARİŞ KODU	3707	
ÜRÜN KODU	GW - 4x12/160A	
AKIM	160 Amper	
KABLO CİNSİ	Tek Damar	Çok Telli
KABLO KESİTİ (mm <sup>2</sup> )	<b>Giriş</b>	<b>Çıkış</b>
	1x10-50 mm <sup>2</sup>	3x10-35 mm <sup>2</sup> 8x2,5-16 mm <sup>2</sup>
	1x10-50 mm <sup>2</sup>	3x6-25 mm <sup>2</sup> 8x1,5-16 mm <sup>2</sup>
Ambalaj Adet	<b>Paket</b>	<b>Koli</b>
	1	18

## TEK KUTUPLU DAĞITICI ÜNİTELER

Birim Fiyat TL / Adet	72.00	
SİPARİŞ KODU	3708	
ÜRÜN KODU	GW - 80A	
AKIM	80 Amper	
KABLO KESİTİ (mm <sup>2</sup> )	Giriş	Çıkış
	1x10-16 mm <sup>2</sup>	4x2,5-6 mm <sup>2</sup> 2x2,5-16 mm <sup>2</sup>
Ambalaj Adet	Paket	Koli
	5	250



Birim Fiyat TL / Adet	148.00	
SİPARİŞ KODU	3709	
ÜRÜN KODU	GW - 125A	
AKIM	125 Amper	
KABLO KESİTİ (mm <sup>2</sup> )	Giriş	Çıkış
	1x10-35 mm <sup>2</sup>	6x2,5-16 mm <sup>2</sup> Köprü 1x6-16 mm <sup>2</sup>
Ambalaj Adet	Paket	Koli
	5	160



Birim Fiyat TL / Adet	152.00	
SİPARİŞ KODU	3710	
ÜRÜN KODU	GW - 160A	
AKIM	160 Amper	
KABLO KESİTİ (mm <sup>2</sup> )	Giriş	Çıkış
	1x10-70 mm <sup>2</sup>	6x2,5-16 mm <sup>2</sup> Köprü 1x6-16 mm <sup>2</sup>
Ambalaj Adet	Paket	Koli
	5	160



## TEK KUTUPLU DAĞITICI ÜNİTELER

Birim Fiyat TL / Adet	435.00	
SİPARİŞ KODU	3711	
ÜRÜN KODU	GW - 250A	
AKIM	250 Amper	
KABLO KESİTİ (mm <sup>2</sup> )	Giriş	Çıkış
	1x35-120 mm <sup>2</sup>	4x2,5-10 mm <sup>2</sup> 5x2,5-16 mm <sup>2</sup> 2x6-35 mm <sup>2</sup>
Ambalaj Adet	Paket	Koli
	3	54



Birim Fiyat TL / Adet	460.00	
SİPARİŞ KODU	3712	
ÜRÜN KODU	GW - 400A	
AKIM	400 Amper	
KABLO KESİTİ (mm <sup>2</sup> )	Giriş	Çıkış
	1x95-185 mm <sup>2</sup>	4x2,5-10 mm <sup>2</sup> 5x2,5-16 mm <sup>2</sup> 2x6-35 mm <sup>2</sup>
Ambalaj Adet	Paket	Koli
	3	54







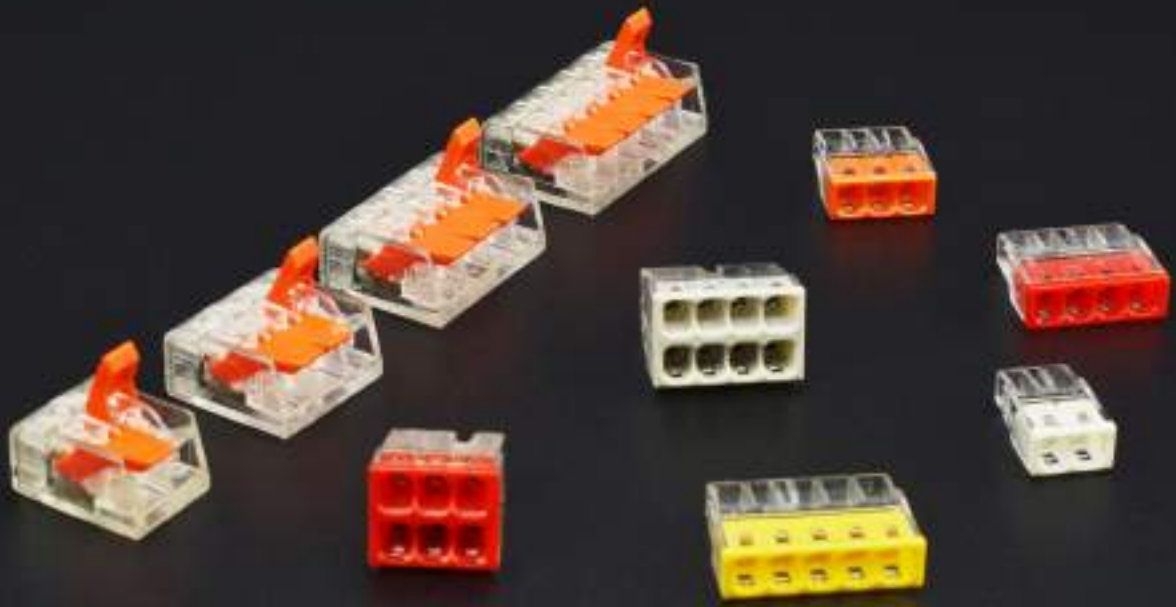

Birim Fiyat TL / Adet	490.00	
SİPARİŞ KODU	3713	
ÜRÜN KODU	GW - 500A	
AKIM	500 Amper	
KABLO KESİTİ (mm <sup>2</sup> )	Giriş	Çıkış
	8x24 mm <sup>2</sup>	4x2,5-10 mm <sup>2</sup> 5x2,5-16 mm <sup>2</sup> 2x6-35 mm <sup>2</sup>
Ambalaj Adet	Paket	Koli
	3	54









**KOMPAKT ÇOK AMAÇLI KLEMENSLER**

## GEÇMELİ BUAT KLEMENSLER

	Sipariş Kodu	Ürün Kodu	Renk	Kablo Kesiti	Ebatlar			Ambalaj Adet		Birim Fiyat TL / Adet
					En	Boy	Yükseklik	Paket	Koli	
	3501	GW 2,5 - 2	Beyaz	0,50 - 2,5 mm <sup>2</sup>	9.8	16.4	5.8	200	10.000	1.80
	3502	GW 2,5 - 3	Turuncu	0,50 - 2,5 mm <sup>2</sup>	13.9	16.4	5.8	200	10.000	2.00
	3503	GW 2,5 - 4	Kırmızı	0,50 - 2,5 mm <sup>2</sup>	17.9	16.4	5.8	100	5.000	2.40
	3504	GW 2,5 - 5	Sarı	0,50 - 2,5 mm <sup>2</sup>	21.9	16.4	5.8	100	5.000	2.60
	3505	GW 2,5 - 6	Kırmızı	0,50 - 2,5 mm <sup>2</sup>	13.8	16.4	11.25	100	5.000	3.30
	3506	GW 2,5 - 8	Gri	0,50 - 2,5 mm <sup>2</sup>	17.8	16.4	11.25	100	5.000	4.30

## ÇOK AMAÇLI KLEMENSLER

	Sipariş Kodu	Ürün Kodu	Kablo Kesiti	Açıklama	Ambalaj Adet		Birim Fiyat TL / Adet
					Paket	Koli	
	3507	GW - 412	0,14 - 4,0 mm <sup>2</sup>	2 İletken Bağlantılı	100	5.000	3.60
	3508	GW - 413	0,14 - 4,0 mm <sup>2</sup>	3 İletken Bağlantılı	100	5.000	4.80
	3509	GW - 414	0,14 - 4,0 mm <sup>2</sup>	4 İletken Bağlantılı	50	2.500	6.00
	3510	GW - 415	0,14 - 4,0 mm <sup>2</sup>	5 İletken Bağlantılı	50	2.500	7.00

Çalışma Sıcaklığı: -40°C + 105°C

Nominal Akım : 32A

Nominal Gerilim : 450V

# MAKARON GRUBU

VE BANT ÇEŞİTLERİ



# ISI İLE DARALAN SİYAH MAKARONLAR

## TEKNİK ÖZELLİKLER



Malzeme : Polyolefin

Daralma Oranı : 2/1

Yanmazlık : Kendi kendine söner

Çalışma Sıcaklığı : -55°C -- +125°C

Sipariş Kodu	Ölçü		Daralmadan Önce (mm)		Daralmadan Sonra (mm)		Makara / Mt.	Koli Miktarı	Birim Fiyat USD / Mt.
	Inch	mm	İç Çap	Cidar Kalınlığı	İç Çap	Cidar Kalınlığı			
4015	—	1	2,0 ± 0,3	0,16 ± 0,05	0,70	0,30 ± 0,05	200	3.200	0.085
4016	—	1,5	2,0 ± 0,3	0,16 ± 0,05	0,80	0,30 ± 0,05	200	2.400	0.097
4017	—	2	2,5 ± 0,3	0,16 ± 0,05	1,00	0,35 ± 0,05	200	3.000	0.115
4003	3/32	2,4	3,0 ± 0,3	0,16 ± 0,05	1,50	0,35 ± 0,05	200	3.000	0.115
4018	—	2,5	3,0 ± 0,3	0,16 ± 0,05	1,25	0,38 ± 0,05	200	2.600	0.15
4019	—	3	3,5 ± 0,4	0,20 ± 0,05	1,50	0,38 ± 0,05	200	2.200	0.16
4004	1/8	3,2	3,5 ± 0,4	0,20 ± 0,05	1,75	0,40 ± 0,05	200	2.200	0.16
4020	—	3,5	4,0 ± 0,4	0,20 ± 0,05	1,75	0,40 ± 0,05	200	1.800	0.17
4021	—	4	4,5 ± 0,4	0,20 ± 0,05	2,00	0,45 ± 0,05	200	1.400	0.20
4022	—	4,5	4,8 ± 0,4	0,20 ± 0,05	2,00	0,47 ± 0,08	100	1.000	0.23
4005	3/16	4,8	5,2 ± 0,4	0,20 ± 0,05	2,60	0,47 ± 0,08	100	1.000	0.23
4023	—	5	5,5 ± 0,4	0,20 ± 0,05	2,50	0,55 ± 0,08	100	900	0.25
4024	—	6	6,5 ± 0,4	0,22 ± 0,05	3,00	0,55 ± 0,08	100	700	0.29
4006	1/4	6,4	7,0 ± 0,4	0,28 ± 0,05	3,50	0,55 ± 0,08	100	700	0.29
4025	—	7	7,5 ± 0,4	0,28 ± 0,05	3,50	0,60 ± 0,08	100	500	0.35
4026	—	8	8,5 ± 0,4	0,30 ± 0,08	4,00	0,60 ± 0,08	100	1.300	0.35
4007	3/8	9,5	10,0 ± 0,5	0,30 ± 0,08	5,00	0,60 ± 0,08	100	1.200	0.35
4028	—	10	10,0 ± 0,5	0,30 ± 0,08	5,00	0,60 ± 0,08	100	1.100	0.39
4008	1/2	12,7	13,0 ± 0,5	0,33 ± 0,10	6,50	0,65 ± 0,08	100	1.000	0.45
4031	—	13	13,5 ± 0,5	0,33 ± 0,10	6,50	0,65 ± 0,08	100	900	0.48
4032	—	14	14,5 ± 0,5	0,33 ± 0,10	7,00	0,70 ± 0,08	100	900	0.56
4034	4/5	16	16,5 ± 0,6	0,35 ± 0,12	8,00	0,75 ± 0,08	100	800	0.75
4036	—	18	19,0 ± 0,6	0,40 ± 0,15	9,00	0,80 ± 0,15	100	700	0.98
4009	3/4	19,1	20,5 ± 0,6	0,40 ± 0,15	10,00	0,80 ± 0,15	100	700	0.98
4038	—	20	20,5 ± 0,6	0,40 ± 0,15	10,00	0,80 ± 0,15	100	600	1.25
4039	—	22	22,5 ± 0,7	0,45 ± 0,15	12,00	0,95 ± 0,15	100	600	1.55
4010	1	25,4	25,6 ± 0,7	0,45 ± 0,15	12,00	0,95 ± 0,15	50	300	1.65
4040	—	30	31,5 ± 0,7	0,50 ± 0,15	15,00	0,95 ± 0,15	50	250	2.15
4011	1 - 1/4	32	33,0 ± 0,7	0,50 ± 0,15	16,50	0,95 ± 0,15	50	250	2.15
4041	—	35	38,0 ± 0,7	0,50 ± 0,15	16,00	1,00 ± 0,15	50	200	2.70
4012	1 - 1/2	38	40,0 ± 0,7	0,50 ± 0,15	20,00	1,00 ± 0,15	50	200	3.00
4042	—	40	40,5 ± 0,7	0,50 ± 0,15	20,00	1,00 ± 0,15	50	200	3.00
4013	2	51	52,5 ± 0,7	0,50 ± 0,15	25,00	1,00 ± 0,15	25	125	3.80
4043	—	60	60,5 ± 0,8	0,52 ± 0,15	30,00	1,00 ± 0,16	25	100	5.10
4044	—	70	70,5 ± 1,0	0,55 ± 0,15	40,00	1,10 ± 0,18	25	75	6.80
4045	—	80	82,0 ± 1,0	0,55 ± 0,15	40,00	1,10 ± 0,18	25	75	7.50
4050	—	90	90,0 ± 1,0	0,55 ± 0,15	45,00	1,10 ± 0,18	25	50	8.50
4046	4	102	105,0 ± 1,0	0,55 ± 0,15	51,00	1,10 ± 0,18	25	50	9.50
4047	—	120	120,0 ± 1,0	0,55 ± 0,15	60,00	1,10 ± 0,18	25	50	13.00
4048	—	150	150,0 ± 1,0	0,55 ± 0,15	76,00	1,10 ± 0,18	25	50	19.00
4049	—	180	180,0 ± 1,0	0,55 ± 0,15	90,00	1,10 ± 0,18	25	25	27.00

# ISI İLE DARALAN RENKLİ MAKARONLAR

ŞEFFAF - BEYAZ - KIRMIZI - MAVİ - SARI - YEŞİL - GRİ

Ölçü		Sipariş Kodu							Makara / Mt.	Koli Miktarı	Fiyat Usd / Mt.
Inch	mm	ŞEFFAF	BEYAZ	KIRMIZI	MAVİ	SARI	YEŞİL	GRİ			
—	1,5	4201	4289	4219	4237	4254	4272	4306	200	3.200	0.11
—	2,5	4202	4290	4220	4238	4256	4273	4307	200	2.600	0.17
1/8	3,2	4203	4291	4221	4239	4257	4274	4308	200	2.200	0.20
—	3,5	—	4292	—	—	4258	—	—	200	1.800	0.21
Yassı	3,5	—	4395	—	—	4390	—	—	100	1.600	0.21
3/16	4,8	4204	4293	4222	4240	4259	4275	4309	100	1.000	0.27
Yassı	4,8	—	4396	—	—	4391	—	—	100	1.500	0.27
1/4	6,4	4205	4294	4224	4241	4260	4276	4310	100	700	0.33
Yassı	6,4	—	4397	—	—	4392	—	—	100	1.500	0.33
Yassı	7	—	4398	—	—	4393	—	—	100	1.400	0.33
3/8	9,5	4206	4295	4226	4242	4261	4278	4311	100	1.200	0.39
—	13	4208	4296	4227	4243	4262	4279	4312	100	900	0.55
4/5	16	4209	4297	4228	4244	4263	4280	4313	100	800	0.85
—	20	4210	4298	4229	4245	4264	4281	4314	100	600	1.50
1	25,4	4211	4299	4230	4246	4265	4282	4315	50	300	1.90
1 - 1/4	32	4212	4300	4231	4247	4266	4283	4316	50	250	2.40
1 - 1/2	38	4213	4301	4232	4248	4267	4284	4317	50	200	3.60
2	51	4214	4302	4233	4249	4268	4285	4318	25	125	4.20
—	60	4215	4303	4234	4250	4269	4286	4319	25	100	5.80
—	80	4216	4304	4235	4251	4270	4287	4320	25	75	8.00
4	102	4217	4305	4236	4252	4271	4288	4321	25	50	11.00



## TEKNİK ÖZELLİKLER

- **Malzeme** : Polyolefin
- **Daralma Oranı** : 2/1
- **Yanmazlık** : Kendi kendine söner
- **Çalışma Sıcaklığı** : -55°C -- +125°C





# ISI İLE DARALAN RENKLİ MAKARONLAR

## KAHVERENGİ

Sipariş Kodu	Ölçü		Daralmadan Önce (mm)		Daralmadan Sonra (mm)		Makara / Mt.	Koli Miktarı	Birim Fiyat USD / Mt.
	Inch	mm	İç Çap	Cidar Kalınlığı	İç Çap	Cidar Kalınlığı			
4322	—	1,5	2,0 ± 0,3	0,16 ± 0,05	0,80	0,30 ± 0,05	200	3.200	0.12
4323	—	2,5	3,0 ± 0,3	0,16 ± 0,05	1,25	0,38 ± 0,05	200	2.600	0.18
4324	1/8	3,2	3,5 ± 0,4	0,20 ± 0,05	1,75	0,40 ± 0,05	200	2.200	0.22
4325	3/16	4,8	5,2 ± 0,4	0,20 ± 0,05	2,60	0,47 ± 0,08	100	1.000	0.29
4326	1/4	6,4	7,0 ± 0,4	0,28 ± 0,05	3,50	0,55 ± 0,08	100	700	0.38
4327	3/8	9,5	10,0 ± 0,5	0,30 ± 0,08	5,00	0,60 ± 0,08	100	1.200	0.44
4328	—	13	13,5 ± 0,5	0,33 ± 0,10	6,50	0,65 ± 0,08	100	900	0.60
4329	4/5	16	16,5 ± 0,6	0,35 ± 0,12	8,00	0,75 ± 0,08	100	800	1.05
4330	—	20	20,5 ± 0,6	0,40 ± 0,15	10,00	0,80 ± 0,15	100	600	1.55
4331	1	25,4	25,6 ± 0,7	0,45 ± 0,15	12,00	0,95 ± 0,15	50	300	2.10
4332	1 - 1/4	32	33,0 ± 0,7	0,50 ± 0,15	16,50	0,95 ± 0,15	50	250	2.80
4333	1 - 1/2	38	40,0 ± 0,7	0,50 ± 0,15	20,00	1,00 ± 0,15	50	200	4.10
4334	2	51	52,5 ± 0,7	0,50 ± 0,15	25,00	1,00 ± 0,15	25	125	4.90
4335	—	60	60,5 ± 0,8	0,52 ± 0,15	30,00	1,00 ± 0,16	25	100	7.50
4336	—	80	82,0 ± 1,0	0,55 ± 0,15	40,00	1,10 ± 0,18	25	75	9.00
4337	4	102	105,0 ± 1,0	0,55 ± 0,15	51,00	1,10 ± 0,18	25	50	13.50



## TEKNİK ÖZELLİKLER

- **Malzeme** : Polyolefin
- **Daralma Oranı** : 2/1
- **Yanmazlık** : Kendi kendine söner
- **Çalışma Sıcaklığı** : -55°C -- +125°C



# ISI İLE DARALAN RENKLİ MAKARONLAR

## SARI YEŞİL

Sipariş Kodu	Ölçü		Daralmadan Önce (mm)		Daralmadan Sonra (mm)		Makara / Mt.	Koli Miktarı	Birim Fiyat USD / Mt.
	Inch	mm	İç Çap	Cidar Kalınlığı	İç Çap	Cidar Kalınlığı			
4102	3/32	2,4	3,0 ± 0,3	0,16 ± 0,05	1,50	0,35 ± 0,05	200	3.000	0.42
4103	1/8	3,2	3,5 ± 0,4	0,20 ± 0,05	1,75	0,40 ± 0,05	200	2.200	0.43
4104	3/16	4,8	5,2 ± 0,4	0,20 ± 0,05	2,60	0,47 ± 0,08	100	1.000	0.44
4105	1/4	6,4	7,0 ± 0,4	0,28 ± 0,05	3,50	0,55 ± 0,08	100	700	0.50
4106	3/8	9,5	10,0 ± 0,5	0,30 ± 0,08	5,00	0,60 ± 0,08	100	1.200	0.68
4107	—	13	13,5 ± 0,5	0,33 ± 0,10	6,50	0,65 ± 0,08	100	900	1.00
4108	4/5	16	16,5 ± 0,6	0,35 ± 0,12	8,00	0,75 ± 0,08	100	800	1.45
4109	—	20	20,5 ± 0,6	0,40 ± 0,15	10,00	0,80 ± 0,15	100	600	1.90
4110	1	25,4	25,6 ± 0,7	0,45 ± 0,15	12,00	0,95 ± 0,15	50	300	2.75
4111	1 - 1/4	32	33,0 ± 0,7	0,50 ± 0,15	16,50	0,95 ± 0,15	50	250	3.70
4112	1 - 1/2	38	40,0 ± 0,7	0,50 ± 0,15	20,00	1,00 ± 0,15	50	200	5.00
4113	2	51	52,5 ± 0,7	0,50 ± 0,15	25,00	1,00 ± 0,15	50	125	7.00
4114	—	60	60,5 ± 0,8	0,52 ± 0,15	30,00	1,00 ± 0,16	25	100	10.00
4115	—	80	82,0 ± 1,0	0,55 ± 0,15	40,00	1,10 ± 0,18	25	75	15.00
4116	4	102	105,0 ± 1,0	0,55 ± 0,15	51,00	1,10 ± 0,18	25	50	23.00



## TEKNİK ÖZELLİKLER

- **Malzeme** : Polyolefin
- **Daralma Oranı** : 2/1
- **Yanmazlık** : Kendi kendine söner
- **Çalışma Sıcaklığı** : -55°C -- +125°C



## İÇİ YAPIŞKANLI DARALAN MAKARONLAR

Sipariş Kodu	Ölçü mm	Daralmadan Önce (mm)	Daralmadan Sonra (mm)			Makara / Mt.	Koli Miktarı	Birim Fiyat USD / Mt.
		İç Çap	Azami İç Çap	Anma Cidar Kalınlığı	Anma Yapışkanlığı			
4418	3/1	3	1.00	1.10 ± 0.10	0.50	200	1.800	0.65
4419	4.8/1.5	4.8	1.50	1.20 ± 0.10	0.50	100	900	0.80
4420	6/2	6	2.00	1.30 ± 0.10	0.50	100	600	1.20
4421	9/3	9	3.00	1.70 ± 0.15	0.60	50	300	1.60
4405	12/4	12	4.00	2.00 ± 0.20	0.80	1.20 Boy	250	2.30
4406	16/5	16	5.00	2.20 ± 0.20	0.80	1.20 Boy	250	3.20
4407	19/6	19	6.00	2.30 ± 0.20	0.80	1.20 Boy	150	4.50
4408	28/9	28	9.00	2.40 ± 0.20	1.05	1.20 Boy	110	5.10
4409	33/10	33	10.00	2.50 ± 0.20	1.05	1.20 Boy	100	5.80
4410	40/12	40	12.00	2.50 ± 0.20	1.05	1.20 Boy	70	6.40
4411	44/14	44	14.00	2.50 ± 0.20	1.05	1.20 Boy	60	7.10
4412	52/18	52	18.00	2.50 ± 0.20	1.05	1.20 Boy	60	8.00
4414	70/25	70	25.00	3.00 ± 0.30	1.35	1.20 Boy	32	11.30
4415	90/30	90	30.00	3.00 ± 0.30	1.35	1.20 Boy	24	16.00
4416	125/40	125	40.00	3.00 ± 0.30	1.35	1.20 Boy	20	20.00



## TEKNİK ÖZELLİKLER

- **Malzeme** : Polyolefin
- **Daralma Oranı** : 3/1
- **Yanmazlık** : Kendi kendine söner
- **Çalışma Sıcaklığı** : -55°C -- +125°C



## KABLO TOPLAMA ÇORABI

Sipariş Kodu	Ölçü	Renk	Esneleme Aralığı		Makara / Mt.	Birim Fiyat USD / Mt.
			Min (mm)	Max (mm)		
4501	3 mm	Siyah	1	6	100	0.23
4502	6 mm	Siyah	3	9	100	0.27
4503	8 mm	Siyah	5	16	100	0.28
4504	10 mm	Siyah	7	19	100	0.34
4505	12 mm	Siyah	8	24	100	0.40
4506	15 mm	Siyah	10	27	100	0.46
4507	20 mm	Siyah	14	30	100	0.53
4508	25 mm	Siyah	18	35	100	0.68
4509	30 mm	Siyah	20	50	50	0.82
4510	40 mm	Siyah	30	60	50	1.10
4511	50 mm	Siyah	40	80	25	1.30

### TEKNİK ÖZELLİKLER

- **Malzeme :** Pet (Polyester)
- **Çalışma Sıcaklığı :** -50°C -- +150°C
- **Dayanım Üst Noktası :** 220 °C
- **Erime Noktası :** +250 °C



## H CLASS CAM ELYAF SİLİKON İZOLELİ MAKARONLAR

Sipariş Kodu	Ölçü	Renk	Makara / Mt.	Koli Miktarı	Birim Fiyat USD / Mt.
4703	2 mm	Kırmızı	200	4.000	0.25
4705	3 mm	Kırmızı	100	2.500	0.38
4706	4 mm	Kırmızı	100	1.500	0.52
4707	5 mm	Kırmızı	100	1.200	0.62
4708	6 mm	Kırmızı	100	1.000	0.77
4709	7 mm	Kırmızı	100	1.000	0.88
4710	8 mm	Kırmızı	50	500	1.00
4711	10 mm	Kırmızı	50	500	1.37
4712	12 mm	Kırmızı	50	500	1.70
4713	14 mm	Kırmızı	50	500	2.05
4714	16 mm	Kırmızı	25	500	2.70
4715	18 mm	Kırmızı	25	400	3.50
4716	20 mm	Kırmızı	25	400	4.50
4717	25 mm	Kırmızı	25	350	8.50
4718	30 mm	Kırmızı	25	200	12.50
4719	35 mm	Kırmızı	25	200	15.00



### TEKNİK ÖZELLİKLER



- **Malzeme :** Silikon İzoleli Cam Elyaf Örgü Makaron
- **Çalışma Sıcaklığı :** -60 °C -- +250 °C

## ERİYEN BANTLAR

SİPARİŞ KODU	ÜRÜN KODU	ÖLÇÜLER	KOLİ ADET	Birim Fiyat USD / Ad.
4801	GWEST - 1401	19 mm x 0.8 mm x 8 m	60	3.50
4802	GWEST - 1402	50 mm x 0.8 mm x 8 m	24	10.00



## İZOLE BANTLAR

	SİPARİŞ KODU	ÜRÜN KODU	ÖLÇÜLER	KOLİ ADET	Birim Fiyat TL / Ad.
	4809	İZOLE BANT	0.13 mm x 19 mm x 9.1 m	500	
	4810	İZOLE BANT	0.50 mm x 50 mm x 9.1 m	60	

## SICAK HAVA TABANCASI

	SİPARİŞ KODU	ÜRÜN KODU	GÜÇ	SICAKLIK	KOLİ ADET	Birim Fiyat USD / Ad.
	4903	GW 2000	2000 W	150 / 300 / 500 °C	10	67.00

# MEKANİK VE HİDROLİK EL ALETLERİ



**tio**<sup>®</sup>  
OTOMASYON

## YÜKSÜK SIKMA PENSELERİ

Sipariş Kodu: 5026	Ürün Kodu: GW - B4
0.25 - 6 mm <sup>2</sup> Yüksek Sıkma Pensesi	
	
	66.00 USD

Sipariş Kodu: 5006	Ürün Kodu: GW - 6
6 - 16 mm <sup>2</sup> Yüksek Sıkma Pensesi	
	
	69.00 USD

Sipariş Kodu: 5005	Ürün Kodu: GW- 5
0.50 - 6 mm <sup>2</sup> Yüksek Sıkma Pensesi	
	
	69.00 USD

Sipariş Kodu: 5008	Ürün Kodu: GW - 8
0.08 - 6 mm <sup>2</sup> Yüksek Sıkma Pensesi (4 Köşe)	
	
	90.00 USD

Sipariş Kodu: 5009	Ürün Kodu: GW - 9
0.08 - 6 mm <sup>2</sup> Yüksek Sıkma Pensesi (6 Köşe)	
	
	105.00 USD

Sipariş Kodu: 5015	Ürün Kodu: GW - 17
25 - 35 mm <sup>2</sup> Yüksek Sıkma Pensesi	
	
	73.00 USD



## İZOLESİZ KABLO UCU VE KONNEKTÖR SIKMA PENSELERİ

Sipariş Kodu: 5021	Ürün Kodu: GW - 11
0.50 - 6 mm <sup>2</sup> İzolesiz Terminal Sıkma Pensesi	
	
	
70.00 USD	

Sipariş Kodu: 5022	Ürün Kodu: GW - 12
1.00 - 10 mm <sup>2</sup> İzolesiz Terminal Sıkma Pensesi	
	
	
70.00 USD	

Sipariş Kodu: 5013	Ürün Kodu: GW - 13
28 - 22 / 24 - 18 (Molex) Konnektör Ucu Sıkma Pensesi (AWG)	
	
	
73.00 USD	

## İZOLELİ KABLO UCU SIKMA PENSELERİ

Sipariş Kodu: 5016	Ürün Kodu: GW - 1
0.50 - 6 mm <sup>2</sup> İzoleli Kablo Ucu Sıkma Pensesi	
	
	
59.00 USD	

Sipariş Kodu: 5017	Ürün Kodu: GW - 7
0.50 - 6 mm <sup>2</sup> İzoleli Kablo Ucu Sıkma Pensesi	
	
	
70.00 USD	

## MULTİ FONKSİYONEL YÜKSÜK VE KABLO UCU SIKMA PENSESİ

Sipariş Kodu: 5070	Ürün Kodu: T03C - 5D
Takım İçerikli Çanta	
<p><b>Takım içeriği</b></p> <p>GW - 5 ..... Yüksük Sıkma 0.5 - 6 mm</p> <p>GW - 6 ..... Yüksük Sıkma 6 - 16 mm</p> <p>GW - 1 ..... Kablo Ucu Sıkma 0.5 - 6 mm</p> <p>GW - 11 ..... İzolesiz Terminal Sıkma 1 - 4mm</p> <p>GW - T8 ..... Kaynaklı Papuç Sıkma 0.5 - 10mm</p>	 <p><b>160.00 USD</b></p>

## KABLO SIYIRMA PENSESİ

Sipariş Kodu: 5028	Ürün Kodu: GW - 318
0.50 - 6 mm <sup>2</sup> Kablo Siyirma Pensesi	
 <p><b>33.00 USD</b></p>	

## KABLO BAĞI SIKMA PENSELERİ

Sipariş Kodu: 5054	Ürün Kodu: TG - 008
2.2 - 4.8 mm <sup>2</sup> Kablo Bağı Sıkma Pensesi	
 <p><b>65.00 USD</b></p>	

Sipariş Kodu: 5055	Ürün Kodu: TG - 009
3.6 - 9 mm <sup>2</sup> Kablo Bağı Sıkma Pensesi	
 <p><b>44.00 USD</b></p>	

Sipariş Kodu: 5056	Ürün Kodu: TG - 011
4.6 - 12 mm <sup>2</sup> Metal Kablo Bağı Sıkma Pensesi	
 <p><b>178.00 USD</b></p>	

## KABLO PABUCU SIKMA PENSELERİ

Sipariş Kodu: 5018	Ürün Kodu: GW - T8
1.5 - 10 mm <sup>2</sup> SKP Sıkma Pensesi	
	
60.00 USD	

Sipariş Kodu: 5019	Ürün Kodu: GW - T9
10 - 16 mm <sup>2</sup> SKP Sıkma Pensesi	
	
60.00 USD	

Sipariş Kodu: 5045	Ürün Kodu: JY - 0650
6 - 50 mm <sup>2</sup> SKP Sıkma Pensesi	
	
82.00 USD	

Sipariş Kodu: 5046	Ürün Kodu: JY - 06120
10 - 120 mm <sup>2</sup> SKP Sıkma Pensesi	
	
165.00 USD	

## HİDROLİK KABLO PABUCU SIKMA PENSELERİ

Sipariş Kodu: 5050	Ürün Kodu: YOQ 120
10 - 120 mm <sup>2</sup> Hidrolik SKP Sıkma Pensesi (Çantalı Set)	
	
150.00 USD	

Sipariş Kodu: 5051	Ürün Kodu: YQK 300
16 - 300 mm <sup>2</sup> Hidrolik SKP Sıkma Pensesi (Çantalı Set)	
	
160.00 USD	

## KABLO KESME MAKASLARI

Sipariş Kodu: 5040

Ürün Kodu: CC- 60

60 mm<sup>2</sup> Kablo Kesme Makası

43.00 USD

Sipariş Kodu: 5041

Ürün Kodu: TC- 100

120 mm<sup>2</sup> Kablo Kesme Makası

72.00 USD

Sipariş Kodu: 5042

Ürün Kodu: TC- 250

250 mm<sup>2</sup> Kablo Kesme Makası

135.00 USD

Sipariş Kodu: 5044

Ürün Kodu: TC - 500

630 mm<sup>2</sup> Kablo Kesme Makası

195.00 USD

Sipariş Kodu: 5067

Ürün Kodu: TCR- 325

325 mm<sup>2</sup> Bakır ve Alüminyum Kablo Kesme Makası

195.00 USD

Sipariş Kodu: 5069

Ürün Kodu: ZCR - 52

500 mm<sup>2</sup> Çok Telli Kablo Kesme Makası

330.00 USD



**GWEST**®



# BUTON SERİSİ ve AKSESUARLARI





## Ø 22mm BUTON SERİSİ YAYLI BUTONLAR

	SİPARİŞ KODU	ÜRÜN KODU	KONTAK	AÇIKLAMA	RENK	KUTU ADET	KOLİ ADET	Birim Fiyat TL / Ad.
 	6001	A5 - 10	1NO	Yaylı Buton	Yeşil	10	300	36.00
	6002	A5 - 01	1NC	Yaylı Buton	Kırmızı	10	300	36.00
	6003	A5 - 11	1NO	Yaylı Buton	Sarı	10	300	36.00
	6004	A5 - 21	1NO	Yaylı Buton	Mavi	10	300	36.00
	6005	A5 - 31	1NO	Yaylı Buton	Beyaz	10	300	36.00
	6006	A5 - 41	1NO	Yaylı Buton	Siyah	10	300	36.00

## İŞARETLİ YAYLI BUTONLAR

	6007	A5 - 10/1	1NO	İşaretleli Yaylı Buton	↑	10	300	42.00
	6008	A5 - 01/2	1NC	İşaretleli Yaylı Buton	●	10	300	42.00
	6009	A5 - 10/3	1NO	İşaretleli Yaylı Buton	↑	10	300	42.00
	6010	A5 - 10/4	1NO	İşaretleli Yaylı Buton	↑	10	300	42.00

## İŞIKLI YAYLI BUTONLAR

	6011	A5 - 10D	1NO	Işıklı Yaylı Buton 220V AC/DC	Yeşil	10	300	66.00
	6012	A5 - 01D	1NC		Kırmızı	10	300	66.00
	6013	A5 - 11D	1NO		Sarı	10	300	66.00
	6014	A5 - 21D	1NO		Mavi	10	300	66.00
	6015	A5 - 31D	1NO		Beyaz	10	300	66.00
	6016	A5 - 10D-110	1NO	Işıklı Yaylı Buton 110V AC/DC	Yeşil	10	300	66.00
	6017	A5 - 01D-110	1NC		Kırmızı	10	300	66.00
	6018	A5 - 11D-110	1NO		Sarı	10	300	66.00
	6019	A5 - 21D-110	1NO		Mavi	10	300	66.00
	6020	A5 - 31D-110	1NO		Beyaz	10	300	66.00
	6021	A5 - 10D-24	1NO	Işıklı Yaylı Buton 24V AC/DC	Yeşil	10	300	66.00
	6022	A5 - 01D-24	1NC		Kırmızı	10	300	66.00
	6023	A5 - 11D-24	1NO		Sarı	10	300	66.00
	6024	A5 - 21D-24	1NO		Mavi	10	300	66.00
	6025	A5 - 31D-24	1NO		Beyaz	10	300	66.00

## Ø 22mm BUTON SERİSİ

### KALICI MANDAL BUTONLAR

	SİPARİŞ KODU	ÜRÜN KODU	KONTAK	AÇIKLAMA	KUTU ADET	KOLİ ADET	Birim Fiyat TL / Ad.
	6027	A5 - 10X	1NO	0 -1 Mandal Buton		10	300
6028	A5 - 20XS	2NO	1-0-2 Mandal Buton		10	300	55.00

### KAYICI MANDAL BUTONLAR

	SİPARİŞ KODU	ÜRÜN KODU	KONTAK	AÇIKLAMA	KUTU ADET	KOLİ ADET	Birim Fiyat TL / Ad.
	6029	A5 - 10X/FU	1NO	0 -1 Mandal Buton		10	300
6030	A5 - 20XS/FU	2NO	1-0-2 Mandal Buton		10	300	60.00

### KALICI - KAYICI MANDAL BUTON

	SİPARİŞ KODU	ÜRÜN KODU	KONTAK	AÇIKLAMA	KUTU ADET	KOLİ ADET	Birim Fiyat TL / Ad.
	6026	A5 - 20XS/F	2NO	1-0-2 Mandal Buton Sağ Pozisyon Kalıcı Sol Pozisyon Kayıcı		10	300

### ANAHTARLI KALICI BUTONLAR

	SİPARİŞ KODU	ÜRÜN KODU	KONTAK	AÇIKLAMA	KUTU ADET	KOLİ ADET	Birim Fiyat TL / Ad.
	6049	A5 - 10Y	1NO	0 -1 Anahtarlı Buton		10	300
6050	A5 - 20YS	2NO	1-0-2 Anahtarlı Buton		10	300	74.00



## Ø 22mm BUTON SERİSİ

## IŞIKLI KALICI MANDAL BUTONLAR



	SİPARİŞ KODU	ÜRÜN KODU	KONTAK	AÇIKLAMA	RENK	KUTU ADET	KOLİ ADET	Birim Fiyat TL / Ad.
	6031	A5 - 10XD	1NO		Yeşil	10	300	<b>67.00</b>
	6032	A5 - 01XD	1NC	0-1 Işıklı Mandal Buton 220V AC/DC	Kırmızı	10	300	
	6033	A5 - 11XD	1NO		Sarı	10	300	
	6037	A5 - 10XD-110	1NO		Yeşil	10	300	<b>67.00</b>
	6038	A5 - 01XD-110	1NC	0-1 Işıklı Mandal Buton 110V AC/DC	Kırmızı	10	300	
	6039	A5 - 11XD-110	1NO		Sarı	10	300	
	6043	A5 - 10XD-24	1NO		Yeşil	10	300	<b>67.00</b>
	6044	A5 - 01XD-24	1NC	0-1 Işıklı Mandal Buton 24V AC/DC	Kırmızı	10	300	
	6045	A5 - 11XD-24	1NO		Sarı	10	300	
	6034	A5 - 20XSD	2NO		Yeşil	10	300	<b>82.00</b>
	6035	A5 - 02XSD	2NC	1-0-2 Işıklı Mandal Buton 220V AC/DC	Kırmızı	10	300	
	6036	A5 - 21XSD	2NO		Sarı	10	300	
	6040	A5 - 20XSD-110	2NO		Yeşil	10	300	<b>82.00</b>
	6041	A5 - 02XSD-110	2NC	1-0-2 Işıklı Mandal Buton 110V AC/DC	Kırmızı	10	300	
	6042	A5 - 21XSD-110	2NO		Sarı	10	300	
	6046	A5 - 20XSD-24	2NO		Yeşil	10	300	<b>82.00</b>
	6047	A5 - 02XSD-24	2NC	1-0-2 Işıklı Mandal Buton 24V AC/DC	Kırmızı	10	300	
	6048	A5 - 21XSD-24	2NO		Sarı	10	300	

## Ø 22mm BUTON SERİSİ





### 40mm KALICI MANTAR BUTON

	SİPARİŞ KODU	ÜRÜN KODU	KONTAK	AÇIKLAMA	RENK	KUTU ADET	KOLİ ADET	Birim Fiyat TL / Ad.
	6054	A5 - 01ZS	1NC	Stop Mantar Buton	 Kırmızı	10	300	<b>48.00</b>

### 40mm KALICI ANAHTARLI MANTAR BUTON

	6075	BZ - 01ZA	1NC	Anahtarlı Stop Mantar Buton	 Kırmızı	10	300	<b>70.00</b>
--	------	-----------	-----	-----------------------------	---	----	-----	--------------





### 40mm KAYICI MANTAR BUTONLAR

	6051	A5 - 01M	1NC	Stop Mantar Buton	 Kırmızı	10	300	<b>42.00</b>
	6052	A5 - 10M	1NO	Start Mantar Buton	 Yeşil	10	300	<b>42.00</b>
	6053	A5 - 41M	1NO	Start Mantar Buton	 Siyah	10	300	<b>42.00</b>

### 40mm KALICI MANTAR BUTONLAR

	6055	A5 - 01ZF	1NC	Stop Mantar Buton		10	300	<b>82.00</b>
	6058	A5 - 01ZFD	1NC	Led Işıklı Stop Mantar Buton 220V AC/DC		10	300	<b>105.00</b>
	6057	A5 - 01ZFD-110	1NC	Led Işıklı Stop Mantar Buton 110V AC/DC		10	300	<b>105.00</b>
	6056	A5 - 01ZFD-24	1NC	Led Işıklı Stop Mantar Buton 24V AC		10	300	<b>105.00</b>







### İKİZ BUTONLAR

	6059	A5 - 11R	1NO+1NC	İkiz Buton	 Yeşil - Kırmızı	10	300	<b>68.00</b>
	6062	A5 - 11RD	1NO+1NC	Işıklı İkiz Buton 220V AC/DC	 Kırmızı - Yeşil	10	300	<b>93.00</b>
	6061	A5 - 11RD-110	1NO+1NC	Işıklı İkiz Buton 110V AC/DC	 Kırmızı - Yeşil	10	300	<b>93.00</b>
	6060	A5 - 11RD-24	1NO+1NC	Işıklı İkiz Buton 24V AC/DC	 Kırmızı - Yeşil	10	300	<b>93.00</b>

## Ø 22mm BUTON SERİSİ AKSESUARLARI

	SİPARİŞ KODU	ÜRÜN KODU	AÇIKLAMA	KUTU ADET	Birim Fiyat TL / Ad.
	6101	A - 10	1NO Start Kontakt	250	15.00
	6102	A - 01	1NC Stop Kontakt	250	15.00
	6103	A - D2	BA9S Led Kontakt Yuvası (Buton için)	200	18.00
	6104	FC	Plastik Buton Rozeti	100	2.40
	6105	FD/60	60mm Acil Stop Etiket	100	7.00
	6106	EC5-1	Acil Stop Butonu Koruma Kapağı	20	35.00
	6107	FH	Buton Koruma Kapağı	4	30.00
	6108	BK	Buton Koruma Kılıfı	100	5.00

## BOŞ KUMANDA KUTULARI





	SİPARİŞ KODU	ÜRÜN KODU	AÇIKLAMA	RENK	KUTU ADET	KOLİ ADET	Birim Fiyat TL / Ad.
	6114	GBK - 1	1'li Boş Kumanda Kutusu	Sarı-Siyah	1	100	24.00
	6116	GBK - 2	2'li Boş Kumanda Kutusu	Sarı-Siyah	1	100	30.00
	6118	GBK - 3	3'lü Boş Kumanda Kutusu	Sarı-Siyah	1	100	38.00
	6120	GBK - 4	4'lü Boş Kumanda Kutusu	Sarı-Siyah	1	50	50.00
	6122	GBK - 5	5'li Boş Kumanda Kutusu	Sarı-Siyah	1	50	74.00
	6124	GBK - 6	6'lı Boş Kumanda Kutusu	Sarı-Siyah	1	50	74.00

## KUTULU ACİL STOP BUTON

	SİPARİŞ KODU	ÜRÜN KODU	KONTAK	AÇIKLAMA	RENK	KUTU ADET	KOLİ ADET	Birim Fiyat TL / Ad.
	6125	LAY2 - KSE542	NC	1'li Mantar Acil Stop Buton	Sarı-Siyah	1	100	62.00

## VİNÇ KUMANDALARI





### VİNÇ KUMANDALAR

	SİPARİŞ KODU	ÜRÜN KODU	AÇIKLAMA	KUTU ADET	KOLİ ADET	Birim Fiyat USD / Ad.
	6701	VK - 2	Vinç Kumanda 2'li Tek Hızlı	1	72	5.80
	6702	VK - 4	Vinç Kumanda 4'li Tek Hızlı	1	48	7.50
	6703	VK - 6	Vinç Kumanda 6'li Tek Hızlı	1	42	10.00
	6704	VK - 8	Vinç Kumanda 8'li Tek Hızlı	1	36	13.00





### ACİL STOPLU VİNÇ KUMANDALAR

	6705	VKB - 3	Vinç Kumanda 3'li Tek Hızlı	1	50	23.00
	6706	VKB - 5	Vinç Kumanda 5'li Tek Hızlı	1	40	32.00
	6707	VKB - 7	Vinç Kumanda 7'li Tek Hızlı	1	30	41.00
	6708	VKB - 9	Vinç Kumanda 9'li Tek Hızlı	1	20	50.00

## Ø 22mm VOLTMETRE

	SİPARİŞ KODU	ÜRÜN KODU	ÇAP (mm)	AÇIKLAMA	RENK	KUTU ADET	KOLİ ADET	Birim Fiyat TL / Ad.
	6501	22 VS - K	22	24 - 550V Led'li Voltmetre	● Kırmızı	10	500	60.00
	6502	22 VS - Y	22	24 - 550V Led'li Voltmetre	● Yeşil	10	500	60.00
	6503	22 VS - S	22	24 - 550V Led'li Voltmetre	● Sarı	10	500	60.00
	6504	22 VS - M	22	24 - 550V Led'li Voltmetre	● Mavi	10	500	60.00
	6505	22 VS - B	22	24 - 550V Led'li Voltmetre	○ Beyaz	10	500	60.00

## Ø 22mm AMPERMETRE

	SİPARİŞ KODU	ÜRÜN KODU	ÇAP (mm)	AÇIKLAMA	RENK	KUTU ADET	KOLİ ADET	Birim Fiyat TL / Ad.
	6511	22 - AS - K	22	0 - 100A Led'li Ampermetre Akım Trafolu	● Kırmızı	10	300	110.00
	6512	23 - AS - Y	22	0 - 100A Led'li Ampermetre Akım Trafolu	● Yeşil	10	300	110.00
	6513	24 - AS - S	22	0 - 100A Led'li Ampermetre Akım Trafolu	● Sarı	10	300	110.00
	6514	25 - AS - M	22	0 - 100A Led'li Ampermetre Akım Trafolu	● Mavi	10	300	110.00
	6515	26 - AS - B	22	0 - 100A Led'li Ampermetre Akım Trafolu	○ Beyaz	10	300	110.00

## Ø 22mm LED'Lİ SİNYALLER



SİPARİŞ KODU	ÜRÜN KODU	ÇAP (mm)	AÇIKLAMA	RENK	KUTU ADET	KOLİ ADET	Birim Fiyat TL / Ad.
6601	22 - K	22	Led Sinyal 220V. AC-DC	● Kırmızı	10	500	14.00
6602	22 - Y	22		● Yeşil	10	500	14.00
6603	22 - S	22		● Sarı	10	500	14.00
6604	22 - M	22		● Mavi	10	500	14.00
6605	22 - B	22		○ Beyaz	10	500	18.00
6606	22 - 110V - K	22	Led Sinyal 110V. AC-DC	● Kırmızı	10	500	14.00
6607	22 - 110V - Y	22		● Yeşil	10	500	14.00
6608	22 - 110V - S	22		● Sarı	10	500	14.00
6609	22 - 110V - M	22		● Mavi	10	500	14.00
6610	22 - 110V - B	22		○ Beyaz	10	500	18.00
6611	22 - 24V - K	22	Led Sinyal 24V. AC-DC	● Kırmızı	10	500	14.00
6612	22 - 24V - Y	22		● Yeşil	10	500	14.00
6613	22 - 24V - S	22		● Sarı	10	500	14.00
6614	22 - 24V - M	22		● Mavi	10	500	14.00
6615	22 - 24V - B	22		○ Beyaz	10	500	18.00

## Ø 16mm LED'Lİ SİNYALLER



SİPARİŞ KODU	ÜRÜN KODU	ÇAP (mm)	AÇIKLAMA	RENK	KUTU ADET	KOLİ ADET	Birim Fiyat TL / Ad.
6621	16 - K	16	Led Sinyal 220V. AC-DC	● Kırmızı	20	1.000	20.00
6622	16 - Y	16		● Yeşil	20	1.000	20.00
6623	16 - S	16		● Sarı	20	1.000	20.00
6624	16 - M	16		● Mavi	20	1.000	20.00
6625	16 - B	16		○ Beyaz	20	1.000	26.00
6626	16 - 110V - K	16	Led Sinyal 110V. AC-DC	● Kırmızı	20	1.000	20.00
6627	16 - 110V - Y	16		● Yeşil	20	1.000	20.00
6628	16 - 110V - S	16		● Sarı	20	1.000	20.00
6629	16 - 110V - M	16		● Mavi	20	1.000	20.00
6630	16 - 110V - B	16		○ Beyaz	20	1.000	26.00
6631	16 - 24V - K	16	Led Sinyal 24V. AC-DC	● Kırmızı	20	1.000	20.00
6632	16 - 24V - Y	16		● Yeşil	20	1.000	20.00
6633	16 - 24V - S	16		● Sarı	20	1.000	20.00
6634	16 - 24V - M	16		● Mavi	20	1.000	20.00
6635	16 - 24V - B	16		○ Beyaz	20	1.000	26.00

## BA9S LED AMPULLER



SİPARİŞ KODU	ÜRÜN KODU	AÇIKLAMA	RENK	KUTU ADET	KOLİ ADET	Birim Fiyat TL / Ad.
6521	BA9SC - K	Led Ampul 220V. AC-DC	● Kırmızı	50	4.000	20.00
6522	BA9SC - Y		● Yeşil	50	4.000	20.00
6523	BA9SC - S		● Sarı	50	4.000	20.00
6524	BA9SC - M		● Mavi	50	4.000	20.00
6525	BA9SC - B		○ Beyaz	50	4.000	24.00
6526	BA9SC - 110V - K	Led Ampul 110V. AC-DC	● Kırmızı	50	4.000	20.00
6527	BA9SC - 110V - Y		● Yeşil	50	4.000	20.00
6528	BA9SC - 110V - S		● Sarı	50	4.000	20.00
6529	BA9SC - 110V - M		● Mavi	50	4.000	20.00
6530	BA9SC - 110V - B		○ Beyaz	50	4.000	24.00
6531	BA9SC - 24V - K	Led Ampul 24V. AC-DC	● Kırmızı	50	4.000	20.00
6532	BA9SC - 24V - Y		● Yeşil	50	4.000	20.00
6533	BA9SC - 24V - S		● Sarı	50	4.000	20.00
6534	BA9SC - 24V - M		● Mavi	50	4.000	20.00
6535	BA9SC - 24V - B		○ Beyaz	50	4.000	24.00



## BUZZER'LAR

## Ø 22mm LED'Lİ BUZZERLAR (90dB)



SİPARİŞ KODU	ÜRÜN KODU	ÇAP (mm)	AÇIKLAMA	RENK	KUTU ADET	KOLİ ADET	Birim Fiyat TL / Ad.
6640	22DS/MS	22	Sesli Led Flaşör İkazlı 220V. AC	● Kırmızı	10	500	54.00
6641	22DS/MS24	22	Sesli Led Flaşör İkazlı 24V. AC/DC	● Kırmızı	10	500	54.00

## MOTORLU SİRENLER



SİPARİŞ KODU	ÜRÜN KODU	AÇIKLAMA	KUTU ADET	KOLİ ADET	Birim Fiyat TL / Ad.
6651	MS - 190	75mm Metal Gövde 220V. AC (110 - 130dB)	1	40	230.00
6652	MS - 190 - 24	75mm Metal Gövde 24V. DC (110 - 130dB)	1	40	230.00

## PANO İÇİ TERMOSTATLAR

Çalışma Ömrü : 100.000 Açma Kapama  
 Ölçüler : 60x33x43  
 Ağırlık : 40 gr  
 Koruma Sınıfı : IP20



SİPARİŞ KODU	ÜRÜN KODU	KONTAK	AÇIKLAMA ve ÇALIŞMA SICAKLIĞI	KUTU ADET	KOLİ ADET	Birim Fiyat TL / Ad.
6682	KTO - 011	NC	Isıtma Termostatı ( 0 - 60°C )	1	300	90.00
6681	KTS - 011	NO	Soğutma Termostatı ( 0 - 60°C )	1	300	90.00

## Ø 22mm POTANSİYOMETRE

	<b>Birim Fiyat TL / Ad.</b>	<b>100.00</b>
	<b>SİPARİŞ KODU</b>	6665
	<b>ÜRÜN KODU</b>	APT22 - 5K
	<b>ÇAP (mm)</b>	22
	<b>KUTU ADET</b>	10
	<b>KOLİ ADET</b>	500
	<b>AÇIKLAMA</b>	5K Potansiyometre Tek Turlu 220V. AC

	<b>Birim Fiyat TL / Ad.</b>	<b>100.00</b>
	<b>SİPARİŞ KODU</b>	6666
	<b>ÜRÜN KODU</b>	APT22 - 10K
	<b>ÇAP (mm)</b>	22
	<b>KUTU ADET</b>	10
	<b>KOLİ ADET</b>	500
	<b>AÇIKLAMA</b>	10K Potansiyometre Tek Turlu 220V. AC

## AKS SERİSİ KAPI SWITCH



SİPARİŞ KODU	ÜRÜN KODU	KONTAK	AÇIKLAMA	KUTU ADET	KOLİ ADET	Birim Fiyat TL / Ad.
6825	AKS - 10	NO	Açık Kontak Kapı Switch	50	500	<b>27.00</b>
6826	AKS - 01	NC	Kapalı Kontak Kapı Switch	50	500	<b>28.00</b>

# SWITCH GRUBU



## GLS SERİSİ LİMİT SWITCH

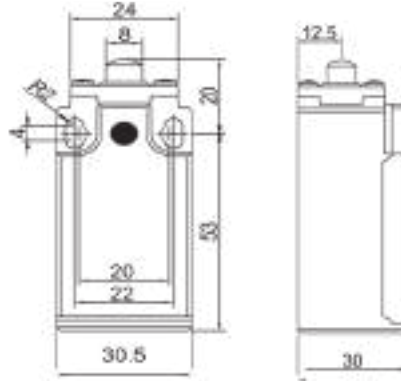

Birim Fiyat USD / Ad.	<b>7.20 \$</b>
SİPARİŞ KODU	6801
ÜRÜN KODU	GLS -101
KUTU ADET	10
KOLİ ADETİ	100
AÇIKLAMA	Kısa Dikey Metal Pim 1NO + 1NC

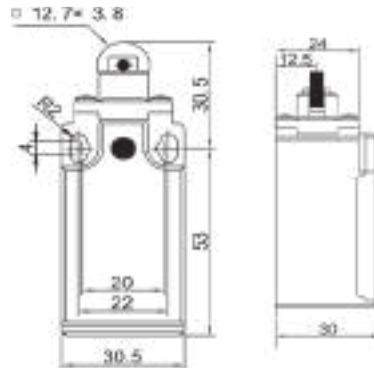

Birim Fiyat USD / Ad.	<b>7.20 \$</b>
SİPARİŞ KODU	6802
ÜRÜN KODU	GLS -103
KUTU ADET	10
KOLİ ADETİ	100
AÇIKLAMA	Dikey Metal Makaralı 1NO + 1NC



**RESETLİ**

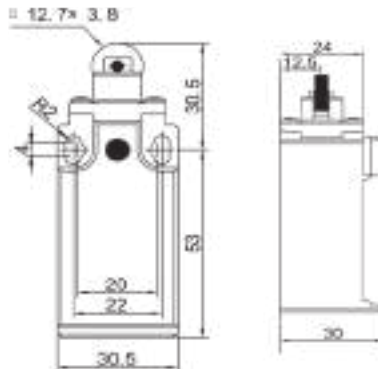

Birim Fiyat USD / Ad.	<b>7.70 \$</b>
SİPARİŞ KODU	6803
ÜRÜN KODU	GLS -103R
KUTU ADET	10
KOLİ ADETİ	100
AÇIKLAMA	Dikey Metal Makaralı Resetli 1NO + 1NC

## GLS SERİSİ LİMİT SWITCH

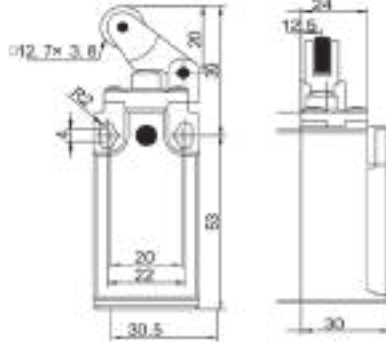

Birim Fiyat USD / Ad.	7.20 \$
SİPARİŞ KODU	6804
ÜRÜN KODU	GLS -111
KUTU ADET	10
KOLİ ADETİ	100
AÇIKLAMA	Açısal Metal Makaralı Tek Yön 1NO + 1NC

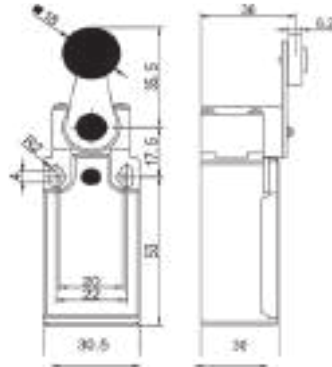

Birim Fiyat USD / Ad.	7.20 \$
SİPARİŞ KODU	6805
ÜRÜN KODU	GLS -121
KUTU ADET	10
KOLİ ADETİ	100
AÇIKLAMA	Dikey Metal Makaralı Çift Yön 1NO + 1NC

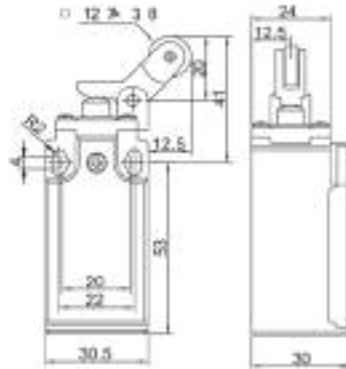

Birim Fiyat USD / Ad.	7.20 \$
SİPARİŞ KODU	6806
ÜRÜN KODU	GLS -127
KUTU ADET	10
KOLİ ADETİ	100
AÇIKLAMA	Ters Açısal Metal Makaralı Tek Yön 1NO + 1NC

## GLS SERİSİ LİMİT SWITCH

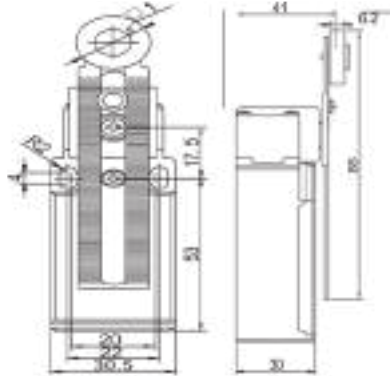

<b>Birim Fiyat USD / Ad.</b>	<b>7.50 \$</b>
<b>SİPARİŞ KODU</b>	6807
<b>ÜRÜN KODU</b>	GLS -131
<b>KUTU ADET</b>	10
<b>KOLİ ADETİ</b>	100
<b>AÇIKLAMA</b>	Ayarlanabilir Metal Makaralı Çift Yön 1NO + 1NC

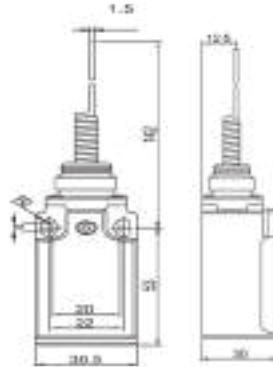

<b>Birim Fiyat USD / Ad.</b>	<b>7.50 \$</b>
<b>SİPARİŞ KODU</b>	6808
<b>ÜRÜN KODU</b>	GLS -161
<b>KUTU ADET</b>	10
<b>KOLİ ADETİ</b>	100
<b>AÇIKLAMA</b>	Çok Yönlü Spiral Tel Uç 1NO + 1NC

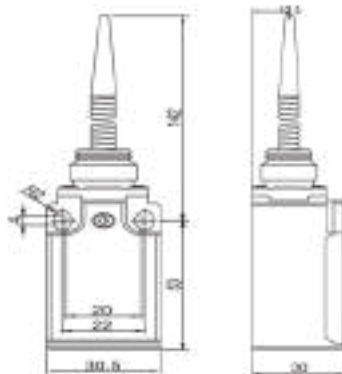

<b>Birim Fiyat USD / Ad.</b>	<b>7.50 \$</b>
<b>SİPARİŞ KODU</b>	6809
<b>ÜRÜN KODU</b>	GLS -171
<b>KUTU ADET</b>	10
<b>KOLİ ADETİ</b>	100
<b>AÇIKLAMA</b>	Çok Yönlü Spiral Plastik Uç 1NO + 1NC

## GLS SERİSİ LİMİT SWITCH

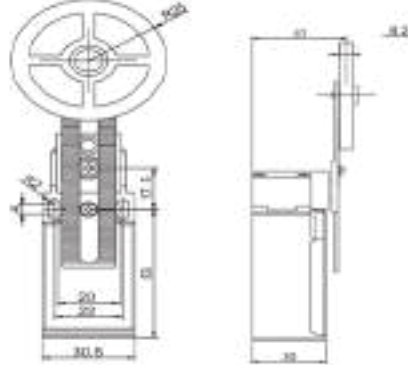

Birim Fiyat USD / Ad.	7.50 \$
SİPARIŞ KODU	6810
ÜRÜN KODU	GLS -191
KUTU ADET	1
KOLİ ADETİ	100
AÇIKLAMA	Ayarlanabilir Kauçuk Makara Çift Yön 1NO + 1NC

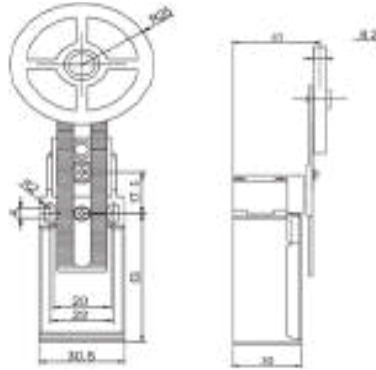

Birim Fiyat USD / Ad.	9.50 \$
SİPARIŞ KODU	6800
ÜRÜN KODU	GLS -191R
KUTU ADET	1
KOLİ ADETİ	100
AÇIKLAMA	Ayarlanabilir Kauçuk Makara Çift Yön Resetli 1NO + 1NC

**RESETLİ**



## AZ SERİSİ MİKRO SWITCH

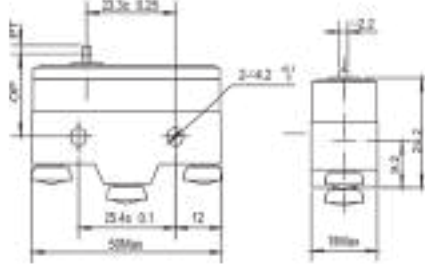

<b>Birim Fiyat USD / Ad.</b>	<b>3.90 \$</b>
<b>SİPARİŞ KODU</b>	6811
<b>ÜRÜN KODU</b>	AZ - 15G - B
<b>KUTU ADET</b>	20
<b>KOLİ ADETİ</b>	360
<b>AÇIKLAMA</b>	İnce Kısa Pimli 15A 1NO + 1NC

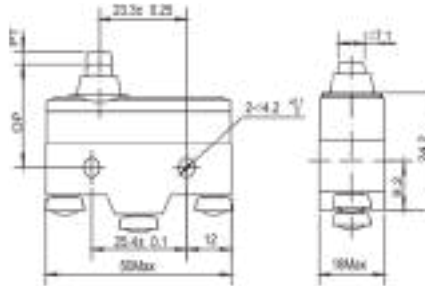

<b>Birim Fiyat USD / Ad.</b>	<b>4.30 \$</b>
<b>SİPARİŞ KODU</b>	6812
<b>ÜRÜN KODU</b>	AZ - 15GD - B
<b>KUTU ADET</b>	20
<b>KOLİ ADETİ</b>	360
<b>AÇIKLAMA</b>	Kalın Uzun Pimli 15A 1NO + 1NC

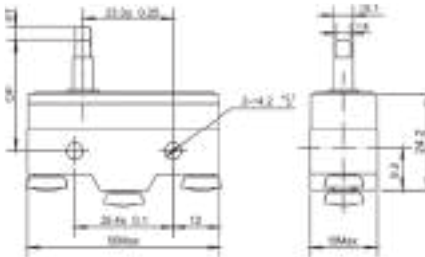

<b>Birim Fiyat USD / Ad.</b>	<b>5.00 \$</b>
<b>SİPARİŞ KODU</b>	6813
<b>ÜRÜN KODU</b>	AZ - 15GS - B
<b>KUTU ADET</b>	20
<b>KOLİ ADETİ</b>	360
<b>AÇIKLAMA</b>	İnce Uzun Pimli 15A 1NO + 1NC

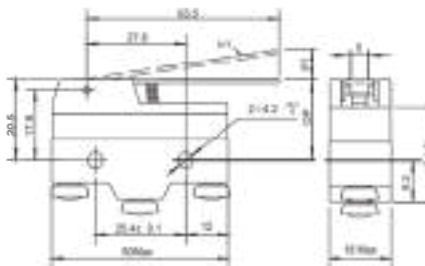

<b>Birim Fiyat USD / Ad.</b>	<b>4.30 \$</b>
<b>SİPARİŞ KODU</b>	6814
<b>ÜRÜN KODU</b>	AZ - 15GW - B
<b>KUTU ADET</b>	20
<b>KOLİ ADETİ</b>	360
<b>AÇIKLAMA</b>	Uzun Palet 15A 1NO + 1NC



## AZ SERİSİ MİKRO SWITCH

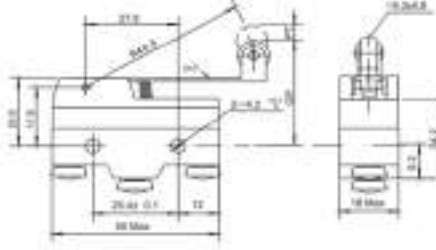

Birim Fiyat USD / Ad.	4.70 \$
SİPARİŞ KODU	6815
ÜRÜN KODU	AZ - 15GW2 - B
KUTU ADET	20
KOLİ ADETİ	360
AÇIKLAMA	Uzun Palet Metal Makaralı 15A 1NO + 1NC

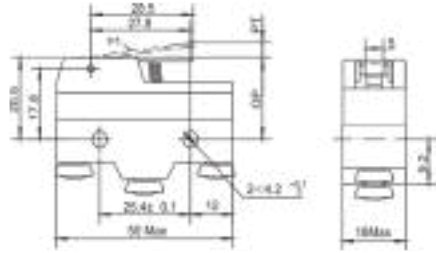

Birim Fiyat USD / Ad.	4.30 \$
SİPARİŞ KODU	6817
ÜRÜN KODU	AZ - 15GW21 - B
KUTU ADET	20
KOLİ ADETİ	360
AÇIKLAMA	Kısa Paletli 15A 1NO + 1NC

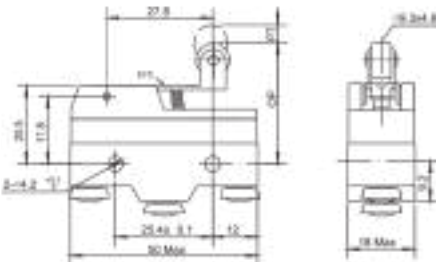

Birim Fiyat USD / Ad.	4.70 \$
SİPARİŞ KODU	6818
ÜRÜN KODU	AZ - 15GW22 - B
KUTU ADET	20
KOLİ ADETİ	360
AÇIKLAMA	Kısa Metal Makaralı 15A 1NO + 1NC

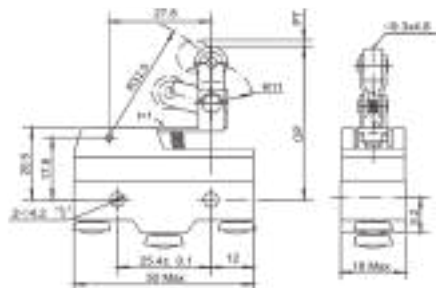

Birim Fiyat USD / Ad.	5.20 \$
SİPARİŞ KODU	6819
ÜRÜN KODU	AZ - 15GW2277 - B
KUTU ADET	20
KOLİ ADETİ	360
AÇIKLAMA	Tahrikli Metal Makaralı 15A 1NO + 1NC



## GMS SERİSİ MİKRO SWITCH



Birim Fiyat USD / Ad.	1.23 \$		
SİPARİŞ KODU	6830	ÜRÜN KODU	GMS - 100C
KUTU ADET	100	KOLİ ADET	1.800
AÇIKLAMA	10 Amper Plastik Pimli Mikro Switch		
Birim Fiyat USD / Ad.	1.23 \$		
SİPARİŞ KODU	6831	ÜRÜN KODU	GMS - 101C
KUTU ADET	100	KOLİ ADET	1.800
AÇIKLAMA	10 Amper Orta Kollu Mikro Switch		
Birim Fiyat USD / Ad.	1.23 \$		
SİPARİŞ KODU	6832	ÜRÜN KODU	GMS - 102C
KUTU ADET	100	KOLİ ADET	1.800
AÇIKLAMA	10 Amper Kısa Kollu Mikro Switch		
Birim Fiyat USD / Ad.	1.37 \$		
SİPARİŞ KODU	6833	ÜRÜN KODU	GMS - 103C
KUTU ADET	100	KOLİ ADET	1.800
AÇIKLAMA	10 Amper Uzun Kollu Metal Makaralı Mikro Switch		
Birim Fiyat USD / Ad.	1.37 \$		
SİPARİŞ KODU	6834	ÜRÜN KODU	GMS - 104C
KUTU ADET	100	KOLİ ADET	1.800
AÇIKLAMA	10 Amper Kısa Kollu Metal Makaralı Mikro Switch		
Birim Fiyat USD / Ad.	1.37 \$		
SİPARİŞ KODU	6835	ÜRÜN KODU	GMS - 105C
KUTU ADET	100	KOLİ ADET	1.800
AÇIKLAMA	10 Amper Uzun Kollu Mikro Switch		
Birim Fiyat USD / Ad.	1.37 \$		
SİPARİŞ KODU	6836	ÜRÜN KODU	GMS - 106C
KUTU ADET	100	KOLİ ADET	1.800
AÇIKLAMA	10 Amper Kıvrık Kollu Mikro Switch		

# AYAK PEDALLARI



**tio**<sup>®</sup>  
OTOMASYON

## AYAK PEDALLARI

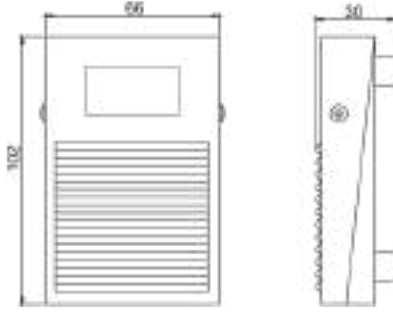

Birim Fiyat USD / Ad.	<b>8.50 \$</b>
SİPARİŞ KODU	6901
ÜRÜN KODU	AP - 1
KUTU ADET	1
KOLİ ADETİ	60
AÇIKLAMA	Metal Döküm Pedal 2mt Kablolu

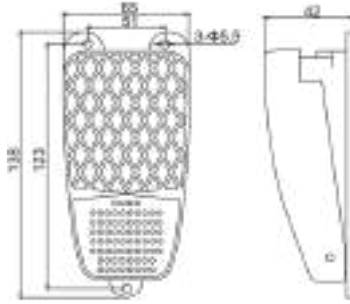

Birim Fiyat USD / Ad.	<b>12.00 \$</b>
SİPARİŞ KODU	6902
ÜRÜN KODU	AP - 2
KUTU ADET	1
KOLİ ADETİ	60
AÇIKLAMA	Alüminyum Döküm Pedal 1mt Kablolu

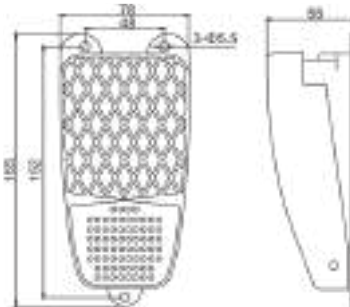

Birim Fiyat USD / Ad.	<b>15.00 \$</b>
SİPARİŞ KODU	6903
ÜRÜN KODU	AP - 3
KUTU ADET	1
KOLİ ADETİ	40
AÇIKLAMA	Alüminyum Döküm Pedal 1mt Kablolu

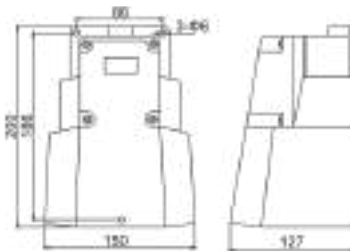

Birim Fiyat USD / Ad.	<b>38.00 \$</b>
SİPARİŞ KODU	6904
ÜRÜN KODU	AP - 9
KUTU ADET	1
KOLİ ADETİ	12
AÇIKLAMA	Metal Döküm Pedal